

T.41.B.3 Solar design of buildings for architects: Review of solar design tools

Subtask B: Methods and Tools for Solar Design



Task 41 - Solar Energy and Architecture
Subtask B - Methods and Tools for Solar Design

Report T.41.B.3
Solar Design of Buildings for Architects: Review of
Solar Design Tools

EDITORS
Miljana Horvat (Ryerson University, Canada)
Maria Wall (Lund University, Sweden)

July 2012

Keywords

Solar energy, buildings, architecture, architects, digital tools, graphic tools, physical tools, software packages, simulation, energy, design process, design tools, design methods, early design phase, active solar systems, solar thermal collectors, photovoltaic (PV) panels, passive solar heating, daylight harvesting, daylighting, passive cooling.

CONTRIBUTORS TO THE REPORT (IN ALPHABETICAL ORDER)

<p>Maria Amtmann Division Buildings & Heating Austrian Energy Agency Mariahilfer Straße 136 A-1150 Vienna AUSTRIA maria.amtmann@energyagency.at</p>	<p><i>SolarBILANZ</i></p>	<p>Émilie Bouffard École d'architecture Université Laval 1 Côte de la Fabrique, Québec, QC, G1R 3V6 CANADA emilie.bouffard.1@ulaval.ca</p>	<p><i>Radiance; RETScreen® International; Eugene H. Kruger building – a case story</i></p>
<p>Jiangtao Du Energy and Building Design Department of Architecture and Built Environment Lund University P.O. Box 118 SE-221 00 Lund SWEDEN Jiangtao.Du@ebd.lth.se</p>	<p><i>Solar charts / sun-path diagrams; DAYSIM</i></p>	<p>Marie-Claude Dubois Subtask B co-leader Energy and Building Design Department of Architecture and Built Environment Lund University P.O. Box 118 SE-221 00 Lund SWEDEN Marie-Claude.Dubois@ebd.lth.se</p>	<p><i>Introduction</i></p>
<p>Marja Edelman École Polytechnique Fédérale de Lausanne Solar Energy and Building Physics Laboratory Bâtiment LE, Station 18 CH-1015 Lausanne SWITZERLAND marja.edelman@epfl.ch</p>	<p><i>Lesosai</i></p>	<p>Doris Ehrbar Lucerne University of Applied Sciences and Arts Dept. of Engineering and Architecture Technikumstrasse 21 CH-6048 Horw SWITZERLAND doris.ehrbar@hslu.ch</p>	<p><i>bSOL; Design Performance Reviewer (DPV); Polysun.</i></p>
<p>Erik Eriksson White arkitekter AB Östgötagatan 100 PO Box 4700 SE-116 92 Stockholm SWEDEN erik.eriksson@white.se</p>	<p><i>IES VE</i></p>	<p>Caroline Hachem Building, Civil and Environmental Engineering, Concordia University 1455 boul de Maisonneuve Ouest Montréal, QC, H3G 1M8 CANADA carolinehachem@gmail.com</p>	<p><i>GoogleSketchUp- The OpenStudio</i></p>
<p>Rolf Hagen Context AS Rjukan Naeringspark, Bygg 270 N-3660 Rjukan NORWAY rolf@context.as</p>	<p><i>VektorWorks</i></p>	<p>Miljana Horvat Subtask B co-leader Dept. of Architectural Science Ryerson University 350 Victoria St., Toronto, ON, M5B 2K3 CANADA mhorvat@ryerson.ca</p>	<p><i>Editor</i></p>

Yixiang Huang *Autodesk® Revit®
Architecture;
Autodesk®
Project Vasari.*

Formerly of: Solar Energy Research
Institute of Singapore (SERIS)
National University of Singapore
(NUS)
7 Engineering Drive 1
Building E3A #06-01
Singapore 117574
seris-info@nus.edu.sg

Jouri KanTERS *Autodesk®
Ecotect®;*

Energy and Building Design
Department of Architecture
and Built Environment
Lund University
P.O. Box 118
SE-221 00 Lund
SWEDEN
jouri.kanTERS@ebd.lth.se

*Kuggen building –
a case story*

Margarethe Korolkow *PV*Sol Expert;
T*Sol Pro;*

IBUS – Institut für Bau-, Umwelt-
und Solarforschung GmbH
Alt-Tempelhof 18
12099 Berlin
GERMANY
margarethe.korolkow@ibus-berlin.de

*Plus Energy
Primary School –
a case story*

Catherine Massart *Solar charts /
sun-path
diagrams;
Physical models;
ArchiCAD.*

Architecture et climat
Université Catholique de Louvain,
Place du levant, 1
1348 LLN
Belgium
catherine.massart@uclouvain.be

Mark Snow *PVsyst*

Faculty of the Built Environment
University of New South Wales
NSW 2052 Sydney
AUSTRALIA
m.snow@unsw.edu.au

Maria Wall *Editor*

Operating Agent
Energy and Building Design
Lund University
P.O. Box 118,
SE-221 00 Lund
SWEDEN
maria.wall@ebd.lth.se

ACKNOWLEDGEMENTS

The authors of this report thank their respective funding agencies for supporting their work:

- NRCan – Natural Resources Canada: CanmetENERGY/Sustainable Buildings and Communities Group, Ottawa, Canada;
- Université Laval, Faculté d'aménagement, architecture et des arts visuels, Québec, Canada;
- Ryerson University, Faculty of Engineering, Architecture and Science, Toronto, Canada;
- ENOVA SF, Ministry of Petroleum and Energy, Norway;
- Swedish Energy Agency;
- Danish Energy Agency;
- The Swiss Federal Office of Energy;
- Hochschule Luzern Technik & Architektur- Kompetenzzentrum Typologie & Planung in Architektur (CCTP);
- SUPSI-ISAAC, Swiss BIPV competence centre;
- Bundesministerium für Wirtschaft und Technologie, Projektträger Jülich, Germany;
- Department of Innovation, Industry, Science and Research (DIISR), Australian Government
- National Research Foundation of Korea: Green Home Technology Research Centre & Zero Energy Green Village Technology Centre.

ABSTRACT

The International Energy Agency Solar Heating and Cooling Programme (IEA SHC) *Task 41: Solar Energy and Architecture*, gathered researchers and practicing architects from 14 countries in the three year project whose aim was to identify the obstacles architects are facing when incorporating solar design in their projects, to provide resources for overcoming these barriers and to help improving architects' communication with other stakeholders in the design of solar buildings.

This report is a result of research done under *Subtask B: Tools and methods for solar design*, of the Task 41. The previous two stages of the Subtask B revealed that there is a broad variety of digital tools that architects are using today in their practices for solar design. The existing tools greatly differ in their complexity, the tasks that they perform, required input data and the output information. This possibly creates additional level of perplexity for those architects who need to choose appropriate tool in order to implement solar strategies at the early design phase, as the choice of tool incur cost, require time for mastering and affect the design workflow in the architectural practice.

The purpose of this report is to provide guidance for architects through the variety of existing tools for solar design, both graphical and digital. Tools presented here were identified as the most used through the international survey of architects also done in IEA SHC Task 41. The intention is not to compare tools against each other, but rather to provide an overview of tools' capabilities to interested architects, in hope that it will help increase their overall awareness regarding tools and inspire them to use some of them when integrating solar strategies in their future designs.

The second part of the report presents three exemplary case stories that describe different design approaches, tools that were used and how the use of solar design tools affected both design process and the final design solution.

TABLE OF CONTENTS

CONTRIBUTORS TO THE REPORT (IN ALPHABETICAL ORDER)	3
ACKNOWLEDGEMENTS	5
ABSTRACT	6
TABLE OF CONTENTS	7
LIST OF FIGURES	9
LIST OF TABLES	9
LIST OF ABBREVIATIONS	10
1. INTRODUCTION	11
1.1. TASK 41: SOLAR ENERGY AND ARCHITECTURE.....	12
1.2. SUBTASK B – METHODS AND TOOLS FOR SOLAR DESIGN	13
1.3. OBJECTIVES OF THIS PUBLICATION	14
2. SOLAR DESIGN TOOLS FOR ARCHITECTS	17
2.1. SIMPLE GRAPHICAL TOOLS	17
2.1.1. <i>Solar charts / sun-path diagrams</i>	17
2.1.2. <i>Physical models</i>	19
2.2. CURRENTLY AVAILABLE DIGITAL TOOLS	22
2.2.1. <i>AutoCAD</i>	23
2.2.2. <i>ArchiCAD</i>	23
2.2.3. <i>GoogleSketchup: The OpenStudio (SketchUp Plugin with EnergyPlus)</i>	26
2.2.4. <i>Autodesk® Revit® Architecture 2012</i>	28
2.2.5. <i>VectorWorks</i>	30
2.2.6. <i>Autodesk® Ecotect®</i>	32
2.2.7. <i>Autodesk® Project Vasari 2.1</i>	35
2.2.8. <i>RETScreen® International</i>	39
2.2.9. <i>Radiance</i>	41
2.2.10. <i>IES VE</i>	44
2.2.11. <i>SolarBILANZ</i>	49
2.2.12. <i>bSol4</i>	52
2.2.13. <i>DAYSIM</i>	59
2.2.14. <i>Design Performance Viewer (DPV)</i>	65
2.2.15. <i>Lesosai</i>	69
2.2.16. <i>Polysun</i>	73
2.2.17. <i>PVsyst</i>	77
2.2.18. <i>PV*Sol Expert 5.0</i>	81
2.2.19. <i>T*Sol Pro 5.0</i>	85
3. EXEMPLARY CASE STORIES	89
3.1. KUGGEN BUILDING, GOTHENBURG, SWEDEN	89
3.1.1. <i>Tools used</i>	90
3.1.2. <i>Methods (process)</i>	90
3.1.3. <i>Aesthetic aspects through tools</i>	90
3.1.4. <i>Technical aspects through tools</i>	91
3.1.5. <i>Economic analysis</i>	92
3.1.6. <i>Barriers to use solar design tools from the architect’s perspective</i>	92
3.2. EUGENE H. KRUGER BUILDING, QUEBEC CITY, QUEBEC, CANADA	94
3.2.1. <i>Tools used</i>	94
3.2.2. <i>Analysis through tools</i>	95
3.2.3. <i>Methods (process)</i>	97
3.2.4. <i>Aesthetic aspects through tools</i>	100
3.2.5. <i>Economic analysis</i>	101
3.2.6. <i>Barriers in using tools for solar design and lessons learned</i>	102
3.3. PLUS ENERGY PRIMARY SCHOOL, HOHEN NEUENDORF (NEAR BERLIN, GERMANY).....	104

3.3.1. <i>Methods (process)</i>	104
3.3.2. <i>Tools used</i>	105
3.3.3. <i>Aesthetical aspects through tools</i>	105
3.3.4. <i>Technical aspects through tools</i>	107
3.3.5. <i>Economic analysis</i>	107
3.3.6. <i>Analysis through tools</i>	107
3.3.7. <i>Barriers in using tools for solar design and lessons learned</i>	108
3.3.8. <i>Involved offices and authorities</i>	108
4. FINAL REMARKS	109
REFERENCES	111
IEA SOLAR HEATING AND COOLING PROGRAMME	114

LIST OF FIGURES

Figure 1: Theoretical Potential of Renewable energy sources compared to the global energy needs	11
Figure 2: Distribution of answers for the question about the most used CAAD software per design phase for all countries (n=1623). Results for the top 5 digital tools. (Source: Horvat et al., 2011)	14
Figure 3: Distribution of answers for the question about simulation software used per design phase, for all countries (n=282). (Source: Horvat et al., 2011)	15
Figure 4: SolarBILANZ, a screenshot of energy balance: (1) heating and DHW calculation, (2) power requirements, (3) solar heat and PV potential and (4) CO ₂ emissions	50
Figure 5: SolarBILANZ, a screenshot: a cost balance	52
Figure 6: Kuggen Building, Chalmers University of Technology, Gothenburg, Sweden. Image source: Wingårdh arkitektkontor	89
Figure 7: Exterior shading element (left) and construction façade detail (right). Image source: Wingårdh arkitektkontor	91
Figure 8: Presentation drawings made with Form•Z by the architectural office (Source: Laurent Goulard).....	95
Figure 9: Qualitative results made with the artificial sky at the School of architecture of Laval University by the GRAP (Source: Potvin and Demers, 2007)	96
Figure 10: Simulation made with the artificial sky at the School of architecture of Laval University made by the GRAP (Source: Potvin and Demers, 2007)	96
Figure 11: Custom fixed exterior sun shading devices used in the building (Source: Laurent Goulard)	97
Figure 12: First and second simulations made during the process of design by the GRAP showing the energy consumption for the heavy laboratory section in kWh/m ² (Source: Potvin and Demers, 2007)	97
Figure 13: Phases of pre-design to construction	98
Figure 14: First organization plans made by the architectural office in collaboration with the GRAP (Source: Laurent Goulard)	99
Figure 15: Second set of organization plans made by the architectural office in collaboration with the GRAP (Source: Laurent Goulard)	99
Figure 16: Final drawings: Bioclimatic strategies (Source: Laurent Goulard)	99
Figure 17: Final drawings: The building on site with the implantation plan (Source: Laurent Goulard)	100
Figure 18: Presentation drawings showing bioclimatic concepts with Form•Z (Source: Laurent Goulard)	101
Figure 19: Left: Simulation showing the overall energy consumption of a reference building, Right: Simulation showing the overall energy consumption of the proposed building (Source: Potvin and Demers, 2007)	102
Figure 20: Thermal bridge before putting insulating material on the metal component of the sun shading device.....	103
Figure 21: Street view (left) and outside view (right) of the Plus Energy Primary School.	104
Figure 22: Daylight concept for the home zones.	105
Figure 23: Classroom model (left) and daylight analysis (right) with Ecotect	106
Figure 24: Optimized classroom model, 1 st of August, 12:00 (left), 24 th of December, 12:00 (right); Radiance.	106
Figure 25: Gymnasium of the school with light dispersing glazing (left); Auditorium/cafeteria with electro chromic glazing (right).	106
Figure 26: Roof with PV system and roof light (left); Screenshot of the PV system planned with PV*Sol (right).	107

LIST OF TABLES

Table 1: Building Performance Simulation (BPS) tools used for various aspects of the design of the Eugene H. Kruger building	94
--	----

LIST OF ABBREVIATIONS

BIM	Building Information Modelling
BIPV	Building integrated photovoltaic
BPS	Building performance simulation
CAAD	Computer-assisted architectural design
CEA	Conceptual energy analysis
CPUC	California Public Utility Commission
DHW	Domestic hot water
EDP	Early design phase
EPBD	Energy Performance Building Directive
EUP	European Union Parliament
FDD	Fault detection and diagnosis
HVAC	Heating, ventilation and air conditioning
IDP	Integrated design process
IPPC	Intergovernmental Panel for Climate Change
LEED	Leadership in Energy and Environmental Design
MPP	Maximum power point
PV	Photovoltaic
PVT	Photovoltaic-thermal
SBRN	Solar Building Research Network (Canada)
ST	Solar thermal

1. INTRODUCTION

Climate change and the scarcity of energy resources are two of the big challenges the world will face in the near future (European Renewable Energy Council, 2010). Two of the main conventional fuels which play central roles in our energy supply are oil and nuclear energy. Fossil fuel prices have drastically increased, especially in the last decade, and, despite occasional oscillation, they keep rising (Federal Institute for Geosciences and natural resources, 2009). For nuclear energy, assuming that the future electricity consumption levels will be the same as those in 2005, and that nuclear power will continue to use the same type of technology, the available resources today would last at least 75 years (Solomon & Bedel, 2003). However, radioactive waste, the treatment costs and related public health risks, as well as the risks of nuclear accidents are among the most serious issues to take into consideration when calculating the real costs of nuclear energy (Bernardo, 2011).

The necessary development of renewable energy sources is further motivated by the urge to slow down climate change and to reduce CO₂ emissions which is unequivocal (IPCC, 2007). For these reasons, profound changes need to be made not only to reduce our energy use, but also to change the way it is produced. On the positive side, recent figures show that all renewable energy sources combined may provide 3078 times the current global energy needs. Among renewable energy sources, solar energy is the one that has by far the largest potential, as shown by Figure 1. By itself it is enough to ensure 2850 times the annual global energy needs (European Renewable Energy Council, 2010). In just one day, the solar energy incident on the earth's surface equals the global energy needs during eight years (Bernardo, 2011). Also, the Canadian Solar Building Research Network (SBRN, 2010) established that in many locations, the solar energy incident on the roof of a typical home far exceeds its energy consumption. There is thus the potential for a building to achieve, on average, net zero energy consumption if the utilization of solar energy to produce electricity, useful heat and daylight is optimized.

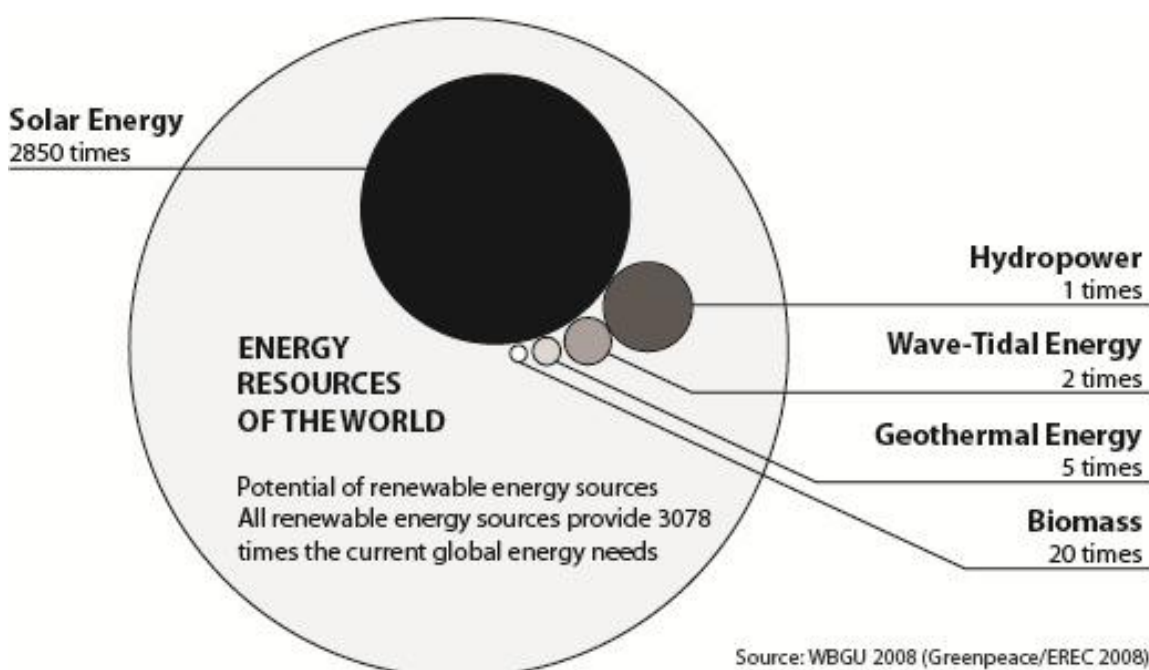

Figure 1: Theoretical Potential of Renewable energy sources compared to the global energy needs (Source: European Renewable Energy Council, 2010)

Despite of these facts, a large portion of the potential to utilize solar energy still remains unused today (Devin 2006). According to the International Energy Agency (IEA, 2009), this is caused by several factors:

- economical factors;
- lack of technical knowledge;
- reluctance to use 'new' technologies; and
- architectural (aesthetic) factors.

While the economic factors are gradually losing grounds as the cost of solar energy systems is slowly decreasing, it is essential to address the last three factors, which are related to workforce capacity. The recent initiatives of European Union Parliament (EUP) and California Public Utility Commission (CPUC), which establish a goal to achieve Net-Zero Energy buildings in the near future, only reinforce the need to seriously address these issues. EUP with the Regulatory of the Energy Performance Building Directive (EPBD) states that all EU member states must require all new buildings to be Net-Zero Energy by 2019 (European Parliament, 2009; EPBD Recast, 2010). In United States, the CPUC has set this requirement to apply to all new residential buildings by 2020 and all new commercial buildings by 2030 (Zero Net Energy, Action Plan: Commercial Building Sector, 2010-2012).

As a consequence of these legislations and initiatives, architects have a significant role to play in the near future, in order to contribute to the success of net-zero energy initiatives, by designing and retrofitting buildings to very low energy use and by implementing solar energy systems and technologies in new and existing buildings. Their role is key to the success of this endeavour mainly because:

1. Early design phase (EDP) decisions of building projects (such as orientation, shape, size of openings) are primarily the responsibility of the architect and,
2. EDP decisions have the greatest impact on the durability and performance of any project (Potvin, 2005).

Larsson (2004) in a study of design methods used in delivering highly efficient buildings, concluded that the greatest advantages in terms of energy use depended upon decisions taken and verified at the very first phase of design. During the first few weeks of design, fundamental decisions are made that have an enormous impact on the energy consumption of the building and, therefore, the lifecycle cost (Livingston, 2007).

1.1. Task 41: Solar Energy and Architecture

Task 41 - Solar Energy and Architecture brought together research and practitioners' expertise from 14 countries in a significant project, which aimed to identify obstacles for solar design while providing recommendations and support for the implementation of solar technologies and strategies in buildings. Countries participating in IEA SHC Task 41 were: Australia, Austria, Belgium, Canada, Denmark, Germany, Italy, Norway, Portugal, Singapore, South Korea, Spain, Sweden and Switzerland. The ultimate goal of Task 41 was to accelerate the development of high quality solar architecture by focusing mainly on the architectural profession, as a key factor in the future evolution and implementation of solar building design in existing as well as new buildings.

The main objectives of Task 41 were:

- To support the development of high quality architecture for buildings integrating solar energy systems and technologies;

- To improve the qualifications of the architects and the communication skills and interactions between engineers, manufacturers, clients and architects.

The expected overall benefit is an increased use of passive and active solar energy in buildings, thus reducing the non-renewable energy consumption and greenhouse gas emissions. The objectives of this task are closely linked to the actions identified by the World Business Council for Sustainable Development i.e. to increase and train workforce capacity, and to evolve energy-efficient designs and technologies that use passive and active approaches (WBCSD, 2009).

To achieve these goals, the work plan of Task 41 was organized according to three main subtasks:

- Subtask A: Architectural quality criteria; guidelines for architects and product developers by technology and application for new product development.
- Subtask B: Methods and tools for solar design, focusing on tools for EDP and tools for the evaluation of integration quality of various solar technologies.
- Subtask C: Integration concepts and examples, and derived guidelines for architects.

1.2. Subtask B – Methods and tools for solar design

Subtask B focused on methods and tools for solar design that architects use at an Early Design Phase (EDP). According to (Pfitzner et al, 2007), the EDP starts with the first client contact and ends with a design with recognizable functions, visualized for easy understanding and with a cost calculation to support the client's 'go/no-go' decisions. During the initial conceptual design process, it is possible to determine inputs that define the correct use of the building and provide a cost-benefit analysis of solar solutions that include future building life-cycle considerations.

Methods and tools used at the EDP should support architects and planners in taking decisions that lead to good solar buildings and support further project development into the construction design phase, while providing an evaluation of various solar technologies. The specific focus of *Subtask B: Tools and methods for solar design* was identifying issues that architects are facing when involved with solar design at the EDP, investigating barriers that prevent architects to get more involved in solar design, determining if the available tools are appropriate for the work flow during the EDP, developing a set of strategies that address the issues, initiating communication between users and tool developers and providing dissemination of knowledge through publications, seminars and series of lectures intended for professionals.

The specific outcomes of the research done up-to-date in Subtask B are:

- Comprehensive review of the existing landscape of digital tools / software packages used in architectural design, published in a report titled *State-of-the-art of digital tools used by architects for solar design. Report T.41.B.1* (Dubois, M.-C. & Horvat, M. (eds.), 2010);
- Identified barriers to the use of current software packages by architects, as well as needs for improvements in digital tools that would support architectural design and integration of solar components at EDP. This was accomplished through a survey of architects done in 14 participating countries and through semi-structured interviews with 20 architectural offices in three countries in order to gain in depth insight into the limitations and problems that architects are facing when designing buildings with solar energy use. The detailed findings of this study were published in the report: *International survey about digital tools used by architects for solar design. Report T.41.B.2*, by (Horvat & Dubois, 2011), as well as in numerous conference and journal papers (Gagnon et al., 2010; Dubois et al., 2011; Korolkow et al., 2011; Kanters, 2011).
- Initiated a communication with digital tools developers (industry) regarding identified barriers and needs in tools for solar design, in order to stimulate the development of adequate and improved digital tools;

- In collaboration with *Subtask C: Concepts, case studies and guidelines*, participated in the development of *The Communication Process* report (Hagen & Jørgensen, 2012), with examples how the digital tool outputs can help improving communications between all stakeholders in the design and building process.
- Actively participated in dissemination of the results of this research through publications in scientific and professional journals, as well as through seminars and continuing education sessions to practitioners (e.g. architects).

1.3. Objectives of this publication

It is generally acknowledged that up to 80% of design decisions affecting the energy performance of a building are taken at the early design stage, which is a stage where architects have the dominant role; the question is whether architects have the right tools to make these decisions.

As one of the somewhat unexpected outcomes of the international survey of architects about tools and methods for solar design revealed, one of the obstacles to architects' involvement in solar design at the EDP lays, for some, in the lack of knowledge about solar design principles as well as about the capabilities of currently available tools for solar design. Informal discussion among the experts involved in the Task 41 disclosed, anecdotally, that solar design, i.e. principles of passive solar design and active solar energy harvesting, are not part of the main curriculum in architectural education in some regions. This may soon pose a problem, as in some municipalities /regions / countries, mostly in Europe, some portions of the energy required to operate building must come from renewable sources. Therefore, architects will soon face the need to more actively get involved of this aspect of the design as well.

Reports published under the Subtask B umbrella revealed that there is a broad variety of digital tools that architects are using today (Dubois & Horvat, Eds., 2010; Horvat et al, 2011). Although these digital tools can be classified in the three main categories (CAAD tools, visualization, tools and simulation tools), for solar design at the early design stage only some of the CAAD tools and simulation tools can be used. The most used CAAD tools identified by architects in the international survey are presented in Figure 2 and the most used simulation tools in Figure 3.

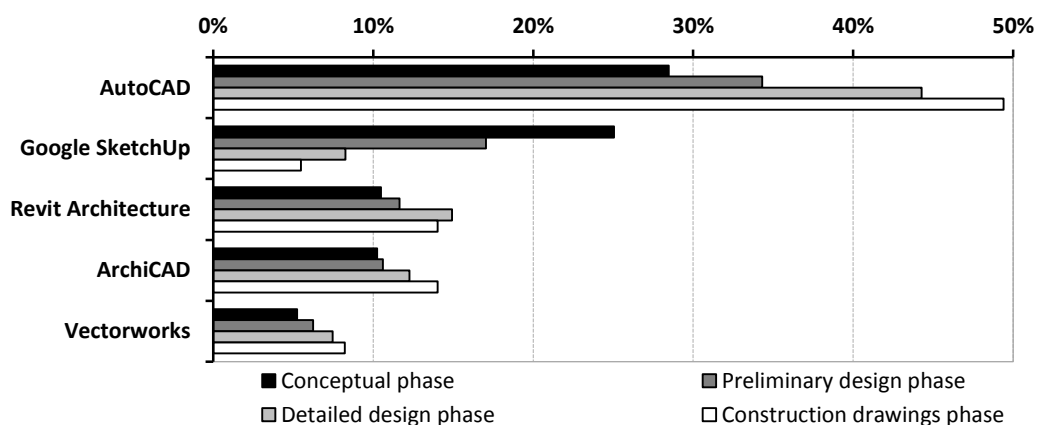

Figure 2: Distribution of answers for the question about the most used CAAD software per design phase for all countries (n=1623). Results for the top 5 digital tools. (Source: Horvat et al., 2011)

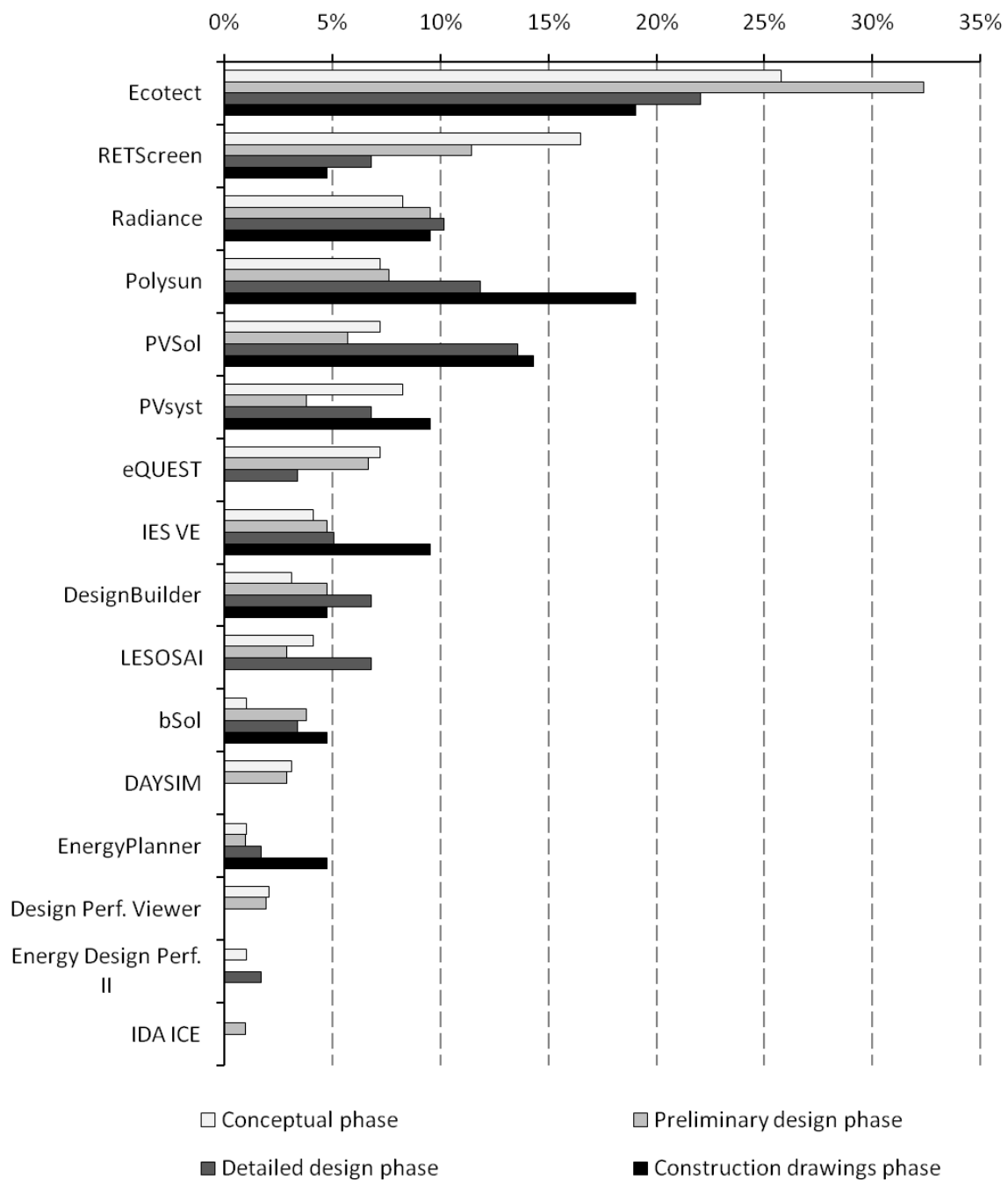

Figure 3: Distribution of answers for the question about simulation software used per design phase, for all countries (n=282). (Source: Horvat et al., 2011)

Although a great number of digital tools for solar design exist today, they are not necessarily quite adequate for architects and the EDP. With the exception of, perhaps, Ecotect that seems to be used by approximately 30% of the survey respondents across all participating countries, there is no other digital tool that is used as much (Figure 3). This possibly creates an additional level of perplexity, as

different tools perform different tasks, require different input (i.e. graphical, numerical, descriptive), and, consequently, produce different types of results (outputs).

As many respondents also stated, the busy schedule also prevents architects in taking time to explore various options and dedicate the time to learn, only to, eventually, discover the limitations of the tool. Therefore, after the first two stages of the Subtask B, the consensus among Task 41 experts was to provide a review of most used digital tools for solar design in contemporary architectural profession, in order to contribute to dissemination and help improving architects' knowledge of currently available tools.

The choice of the selected tools that will be presented here resulted directly from the responses of the international survey of architects in 14 participating countries: top 5 used CAAD tools (Figure 2) and simulation tools, already shown in Figure 3.

The purpose of this publication is not to make a comparative review of the tools for solar design, but rather to present their capabilities to those interested, in hope that it will help increase their overall awareness, and, possibly, provide inspiration and incentive for the future choice of tool(s).

The review is organised into the following sections:

- graphical / physical tools for solar design;
- digital tools for solar design, that include both:
 - CAAD tools;
 - Building Performance Simulation (BPS) tools.

The review was carried out by using the same building model as input for all tools, to the extent possible. Sometimes the tool did not allow for handling the input as provided and simplifications had to be carried out.

In addition, in the second part, the report presents three exemplary case stories that intend to convey a valuable experience as they describe different design approaches, which tools were used and how the use of solar design tools affected the design process and final architectural design.

2. SOLAR DESIGN TOOLS FOR ARCHITECTS

2.1. Simple graphical tools

Solar design of buildings is very much site specific. Architectural building design must respond to both exterior context and interior programming. Using simple graphical tools is one of the ways to develop and evaluate solutions specific to the building being designed. They allow the architect to perform a number of tasks quickly and accurately such as determining shadows' cast, determining spatial relationships between buildings and sun access to public space or to the internal spaces of buildings, etc. In some cases, the important information is not really quantifiable at all, but is qualitative or perceptual. Two main categories of simple graphical tools are presented in the following section of this document: solar charts /sun-path diagrams and physical models. Solar charts and sun-path diagrams are used to understand the movement of the sun for a specific location and to determinate sunny and shady areas on a specific site. Physical models are the best way to evaluate the designs that are developed, since there is virtually no scale factor for lighting in scale models.

2.1.1. Solar charts / sun-path diagrams

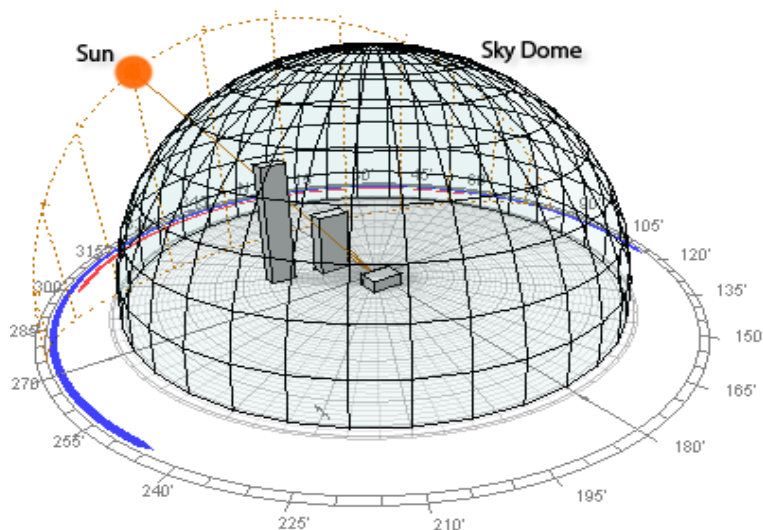

Source: Marsh, 2007

Sun-path diagrams represent horizontal or vertical projection of the imaginary sky dome placed over building site. Solar diagrams are used to graphically assess solar exposure of a reference point (e.g. a building, or a part of a building) throughout a year.

Sky dome:

Horizontal lines represent altitude;
Vertical lines represent the azimuth.

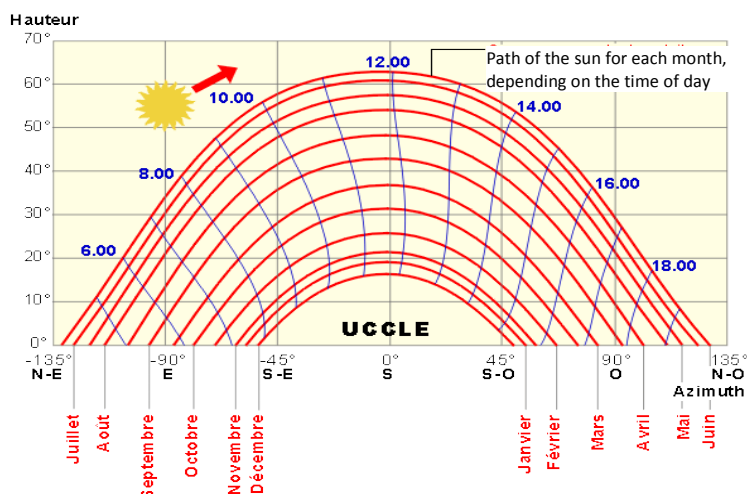

Vertical sun-path diagram: projection of the sky dome on the vertical plane

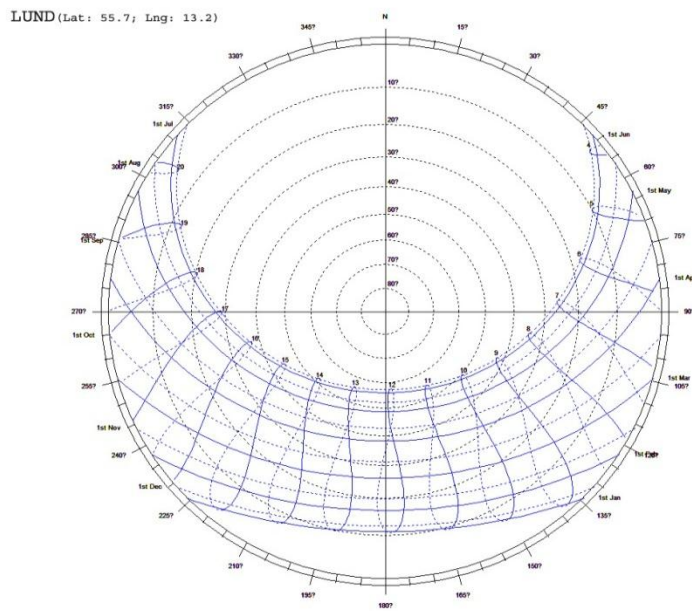

The sun-path diagrams show the movement of the sun in Lund (Sweden) and Montreal (Canada) (north hemisphere).

Stereographic Sun-path diagram for Lund, Sweden

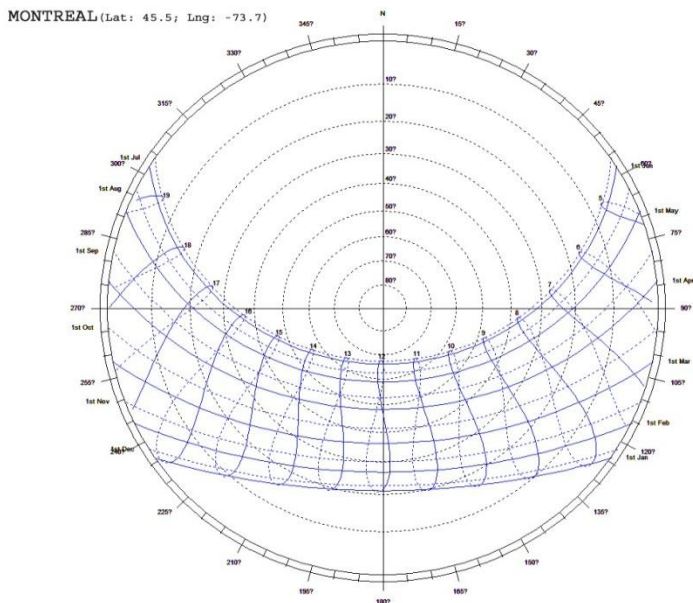

According to a daylight code (BS8206-2, 1992), the lines in a sun-path diagram can be explained as follows: *'the concentric circles on a stereographic sun-path diagram represent angles of elevation above the horizon; the scale and compass points around the perimeter represent orientation. Each of the long curved arcs gives the sun-path, the solar altitude and azimuth, for a particular day; the shorter, converging, lines give the time of day.'*

Stereographic Sun-path diagram for Montreal, Canada

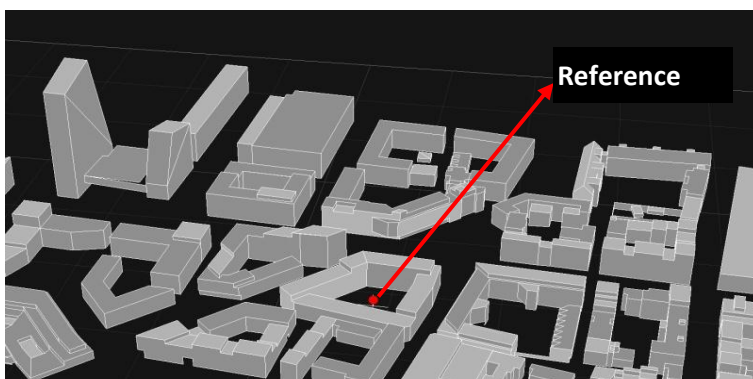

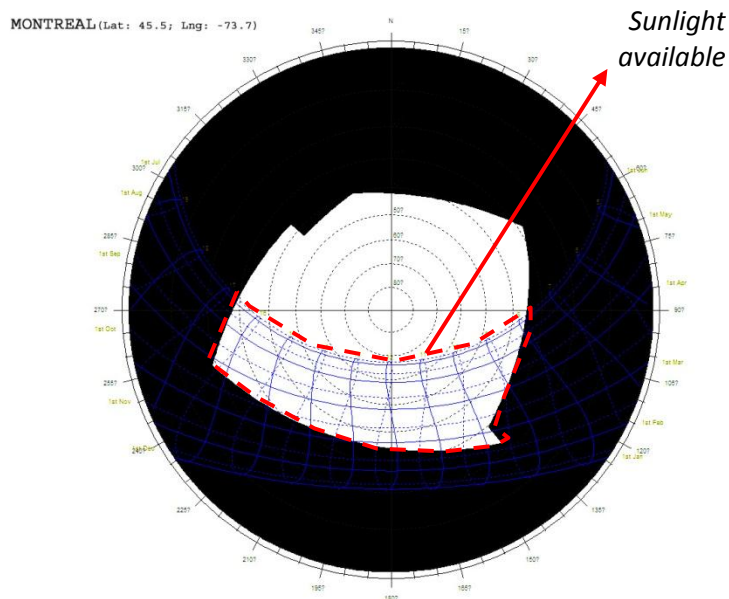

Stereographic Sun-path diagram and shading mask for particular reference point in Montreal, Canada

The figure on the left shows how a reference point in the urban area can be plotted on the diagram (Autodesk, 2010). On the sun-path diagram, the outline of the unobstructed sky (enclosed by red dash line) shows that in winter no sunlight could reach the reference point between sunrise and sunset; in warm seasons, however, there is possible sunlight between approximately 9 a.m. and 16 p.m., solar time (approximately GMT). The black areas are the obstructions superimposed on the diagram. The obstruction positions in a sun-path diagram correspond to the real world by: up obstructions – northern buildings, down obstructions – southern buildings, right obstructions – eastern buildings, left obstructions – western buildings (BS8206-2, 1992).

Limitations:

A sun-path diagram is a theoretical analysis tool which gives a potential sun shining time (BS8206-2, 1992). Using solar geometries and project laws, the calculations of sunlight availability are completely independent of the weather conditions. It might give impractical results in sites where a cloudy sky is dominant.

2.1.2. Physical models

The Light and Building Laboratory of the Scientific Centre and Technique of Construction (BBRI), situated at Limelette in Belgium, offers many tools to evaluate the natural lighting of buildings, which are based on model measurements. These tools have been developed in collaboration with the Catholic University of Louvain (Bodart et al. 2006; Bodart et al., 2008).

Sky modelling

The two first tools, allow us to evaluate on a reduced model the illuminance and luminance originated from the sky.

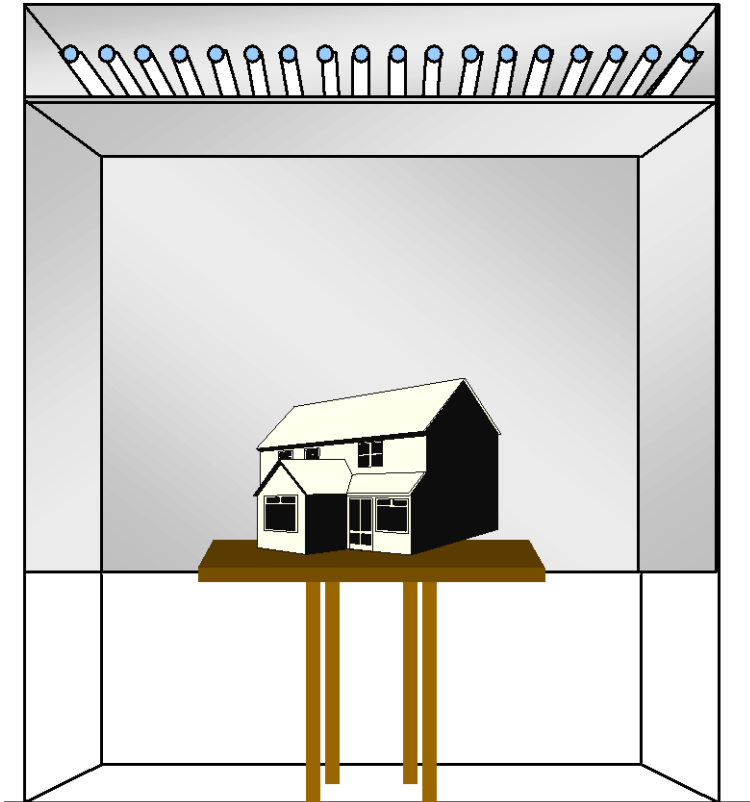

Mirror box

The “mirror box” is made of a closed room coated with highly reflecting mirrors and a luminous ceiling made of fluorescent tubes hidden by a diffusing material. It allows to simulate an overcast CIE (International commission on illumination) and to thereby evaluate the daylight factor at any area of the modelled building

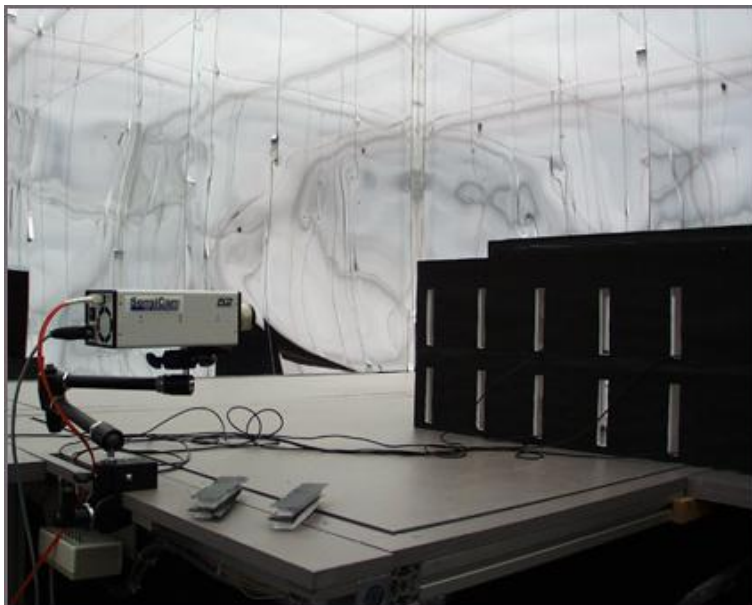

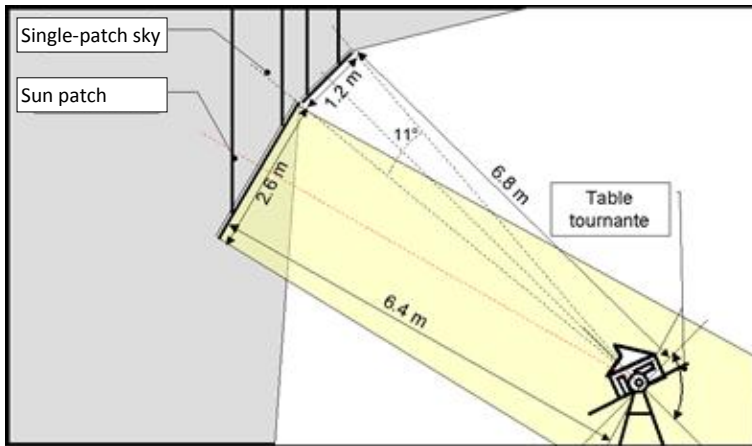

One-patch sky and sun

The “dome” type sky allows user to simulate the sky distribution. It consists of a luminous source and a turning table on which the model is placed. The light source that models the sky, stays still and simulates only a part of the celestial sphere (more precisely 1/145th).



The image on the left shows single-patch sky and sun.

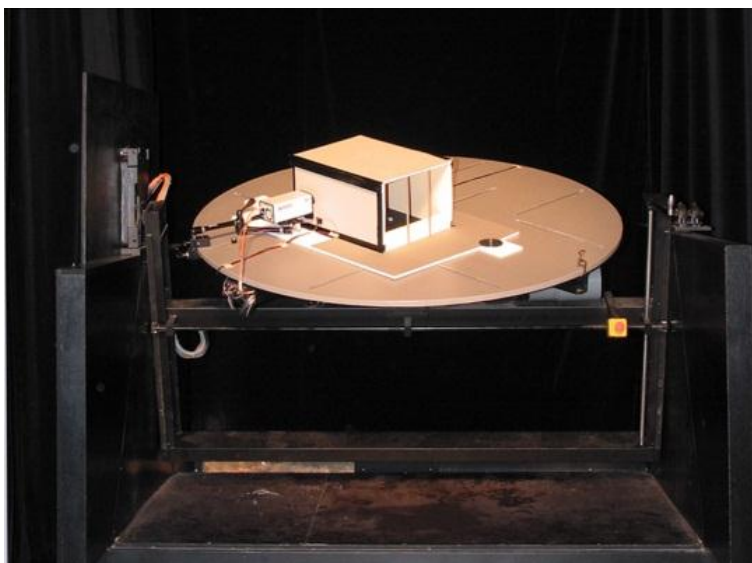

The complete dome can be reconstituted by 145 different angle views of the model that are succeeded by its double rotation system (rotation on two orthogonal axes). This tool allows user to evaluate local illuminance at any given time of the year.

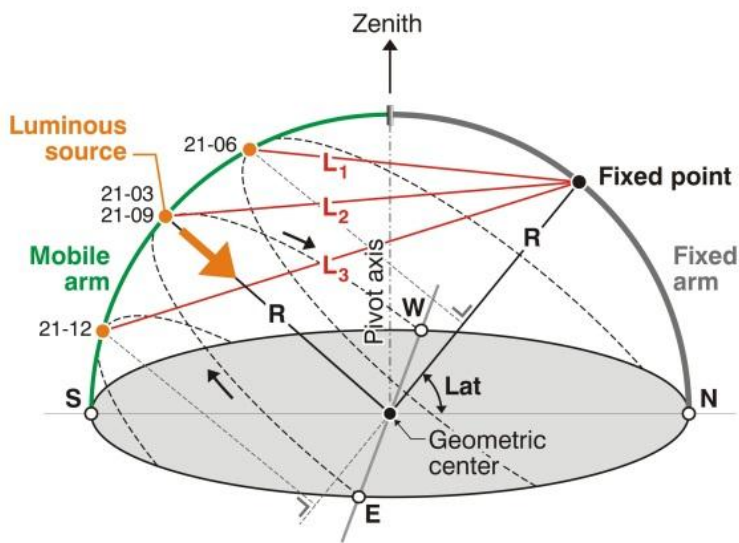

Modelling of the sun

The **mechanical sun** is a tool composed by a mobile lamp that moves around a reduced model while portraying the sun movement for a specific latitude (stationary point).

The lamp is motored and its course is controlled by a remote control. This simulator is used to visualize the sun-path as well as the shadows or sunspot associated to this movement on a building or on group of buildings.

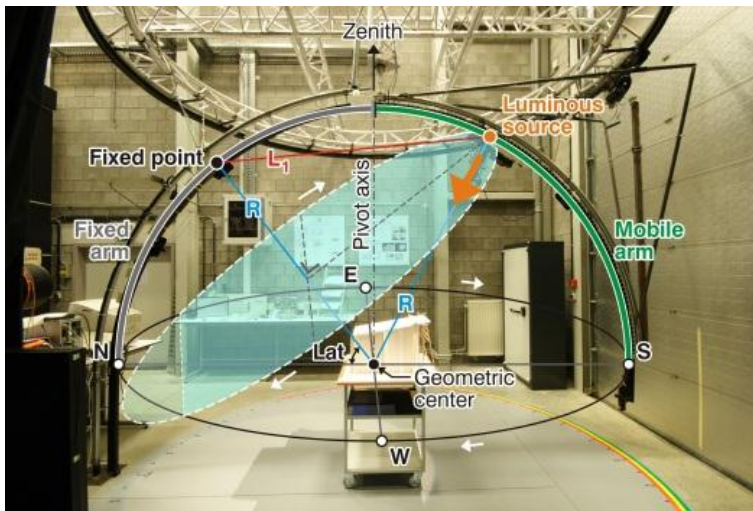

The single-patch artificial sun is a simulator that allows a more detailed study than the one offered by the mechanical sun because it can combine observations and measures. It follows the well-known principle of the Heliodon based on the rotation of a model on two axes, so that the positions of the sun of a specific locality can reproduced.

2.2. Currently available digital tools

Similarly to other aspects of today's life, the use of digital tools achieved a dominant role in recent years in contemporary architectural practice. Besides dramatically improving the speed of delivering design documentation, digital tools also provide various outputs that can be used in facilitating and improving communication between actors in the design and construction process, i.e. between architects and client (and client's advisors), architects and engineers, consultants, etc. (Dubois, M.-C. & Horvat, M. (eds.), 2010).

The following section, and the greatest part of this report, is dedicated to present capabilities of various digital tools that can assist architects in solar building design. Some of the tools deliver only qualitative information, which still can be helpful especially at the early design phase (EDP); other tools, predominantly building performance simulation (BPS) tools or specialised tools for sizing active solar components, provide qualitative output, but also require more detailed and time consuming input. This section is also organised in the similar manner: it starts with CAAD tools that

mostly provide qualitative output in solar modelling, and then continues with BPS and specialised tools for solar design.

2.2.1. AutoCAD

According to (Horvat & Dubois, 2011), AutoCAD is still by far the most predominant digital tool used in architectural practices around the world, and that is the reason that it found its place in this report. However, although it is used in all design phases, AutoCAD is generally more suitable for the detailed design and construction drawing phase of the project.

AutoCAD does not support any form of solar modelling.

2.2.2. ArchiCAD

Solar modelling in ArchiCAD

ArchiCAD is an architectural BIM/CAD software supplied by Graphisoft. The last version is ArchiCAD 14. It is a 3D design tool that permits basic solar analyses:

- Sun/ shade analyses
- Solar animation
- Visualisation of solar installations

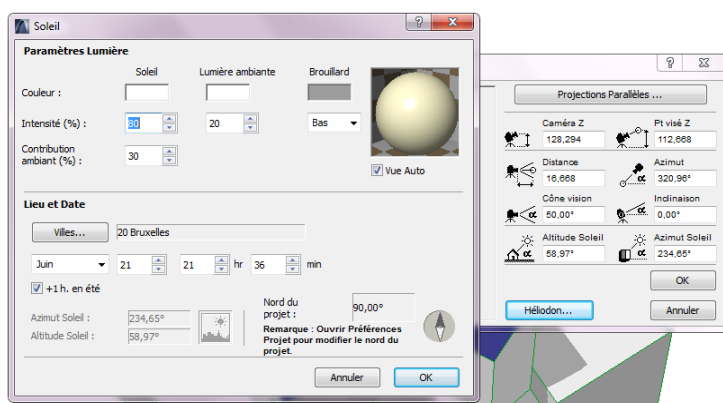

By entering the location of the project (longitude and latitude), the date and the time, ArchiCAD can generate a sunlit object for any position in the world. Using this object ArchiCAD can render correct shadow positions for the given date and time, allowing visual assessment of solar access and shading

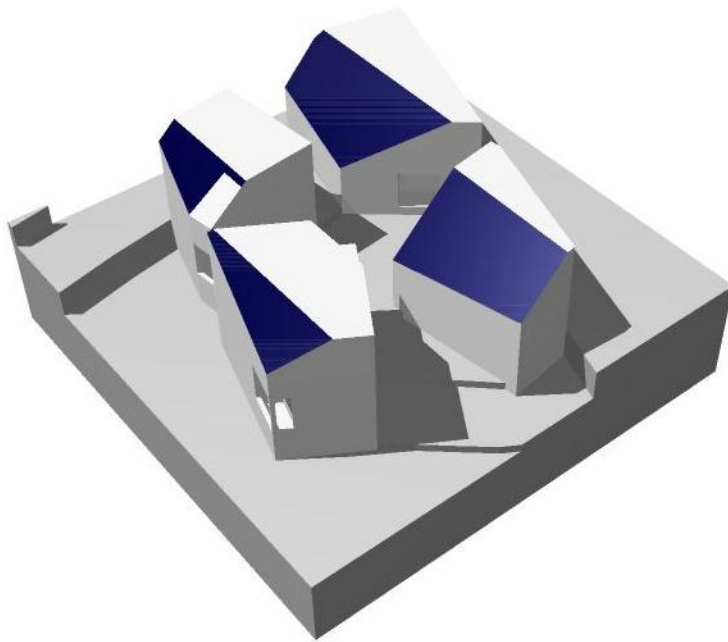

By generating or importing site and landscape data, solar access to the project site as well as overshadowing from surrounding objects can be assessed. Solar access to building surfaces can be modelled in order to determine suitable locations for installation of solar systems, as well as possible design modifications to increase solar access

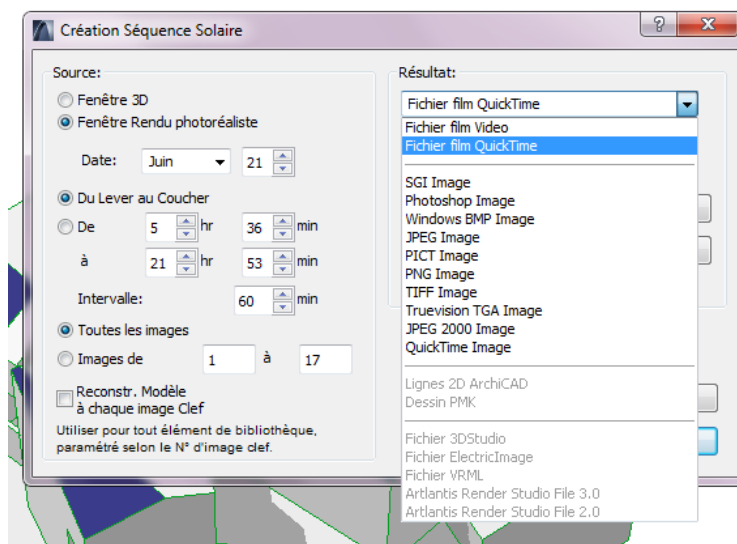

Solar animation

ArchiCAD can create a solar animation for a given date and geographical position, with period (from sun rise to sunset for example) and a time step. The output is generated as a movie or as a series of images. Different formats are possible. This can be used to identify the times of solar access and shading on different points of the project, allowing the user to identify likely positions for solar installations, as well as potential exposure and shading issues

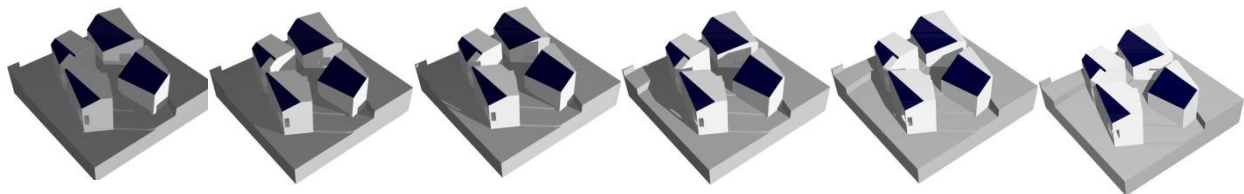

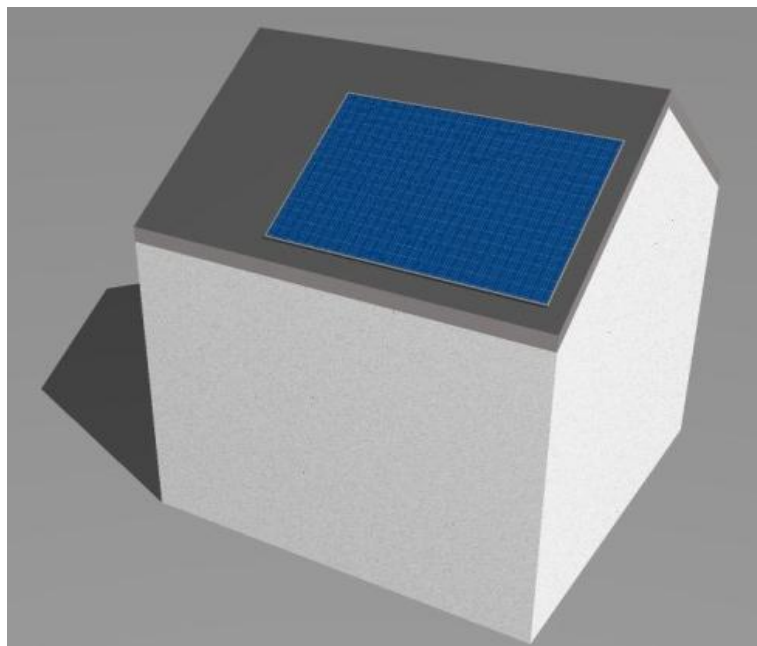

Visualisation of solar components

A really easy and basic way of representing solar installation on buildings is to create a glassy dark material and assign it to the panel's surfaces. This is shown in the previous images.

This does not show any joints or structures.

ArchiCAD's library has a photovoltaic solar panel element. The dimensions (width, length and thickness) and the slope can be modified. The shape is rectangular and the pattern of the cells is constant. The frame is shown but cannot be modified.

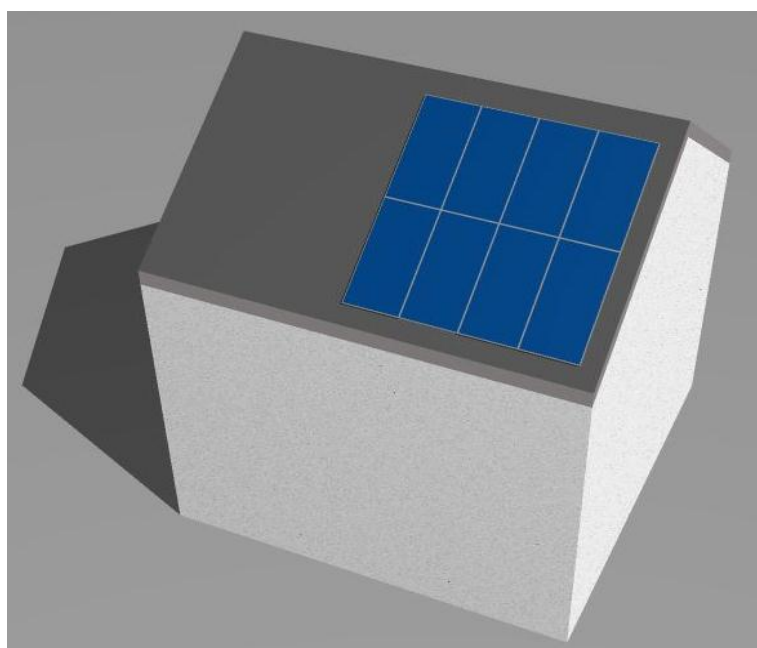

An object can be uploaded in the library. Today, a few modules of solar thermal collectors and photovoltaic panels can be found and downloaded to be used in ArchiCAD.¹

The example shown is a solar thermal collector. Size and number of modules can be modified, as well as materials for the panels, frame, etc. The shape is rectangular.

Additional notes

It should be noted that all ArchiCAD outputs are qualitative. The program cannot supply quantitative solar data, e.g. for use in energy or daylighting calculations.

¹ Modules of solar thermal and photovoltaics panels for AutoCAD and ArchiCAD have been developed by the University of Applied Sciences and Arts of Italian Switzerland (Scuola universitaria professionale della Svizzera italiana, SUPSI) as a sub-project of Task 41, and are available for download in English, French, Italian and German at http://www.bipv.ch/index.php?option=com_content&view=article&id=338&Itemid=306&lang=en

2.2.3. GoogleSketchup: The OpenStudio (SketchUp Plugin with EnergyPlus)

OpenStudio Plug-in for Google SketchUp is created by the National Renewable Energy Laboratory for the U.S. Department of Energy.

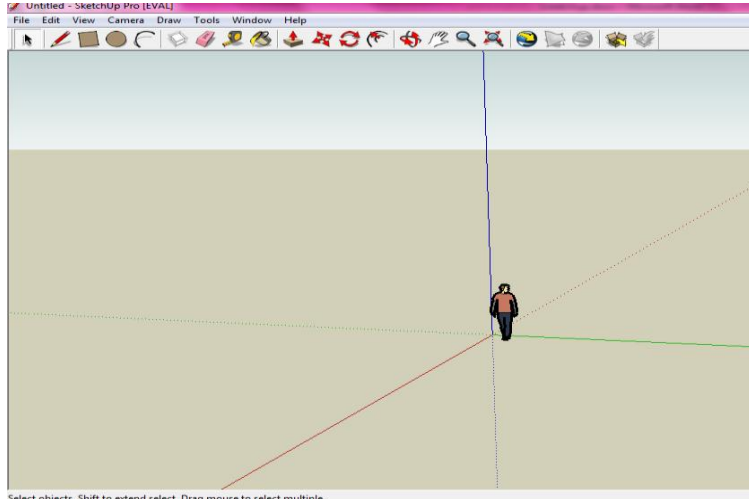

Google SketchUp

The new version of SketchUp (free version) does not give the possibility to import AutoCAD files.

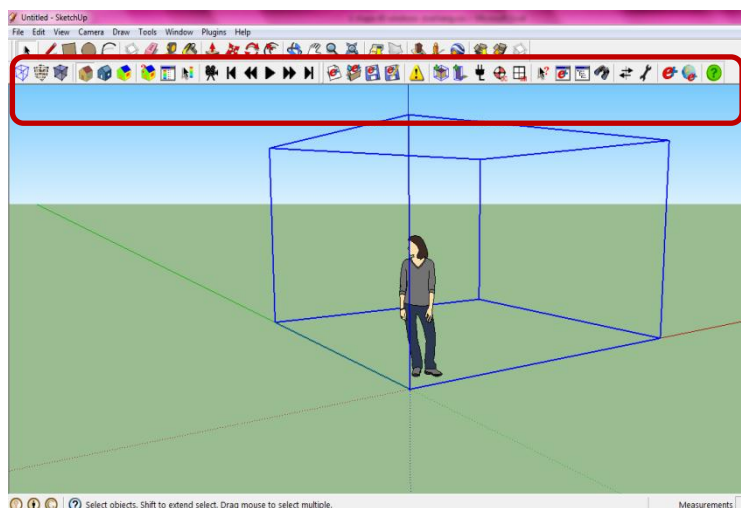

OpenStudio Plug-in

To be able to perform energy simulations the plug in is needed, shown on the left circled in red.

The model should be created (or imported) in an “energy plus zone”, (shown as a blue frame on the image on the left) to perform a solar energy analysis.

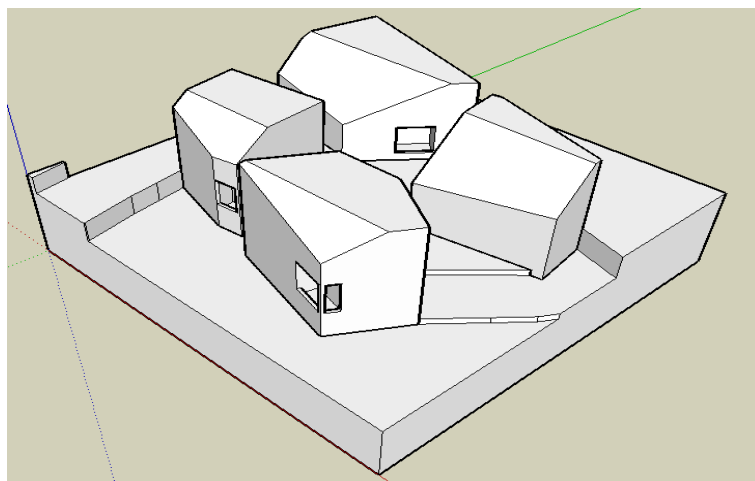

Model in Google SketchUp

If the model is not in colours, then it is not an object in EnergyPlus, and therefore energy analysis cannot be performed.

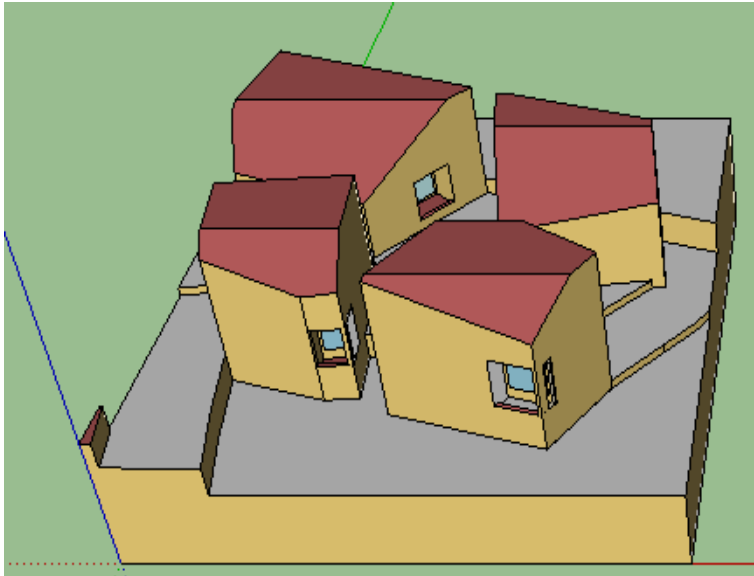

Model in OpenStudio

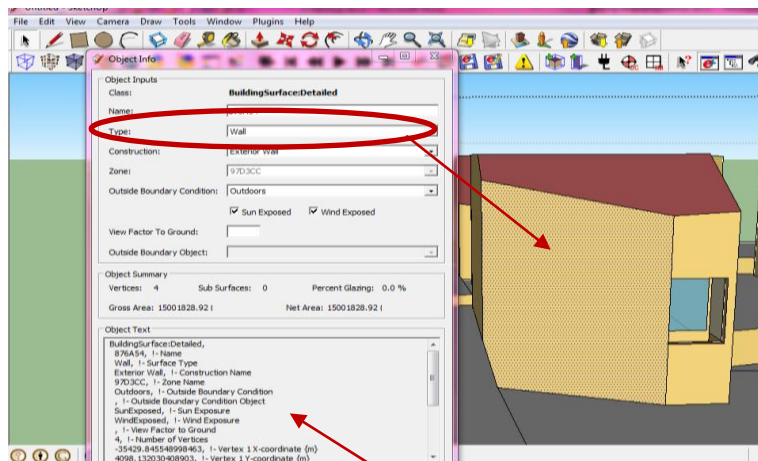

Details of a surface

Highlights of OpenStudio Plug-in include the ability to:

- Create, edit and view EnergyPlus input files within SketchUp.
- Add internal gains and simple outdoor air (i.e. natural ventilation) for load calculations.
- Add the ideal HVAC system for load calculations.
- Set and change default constructions.
- Add daylighting controls and illuminance map.
- Details can be added according to the available level of details of the model.

The results are obtained as spreadsheets or text output files.

The program can perform the following analyses:

1. Solar radiation incident, absorbed and transmitted.
2. Advanced shading (including scheduled controls).
3. Solar heat gain from windows.
4. Advanced daylighting.

Constructions can be detailed layer by layer, or can be selected from an existing database.

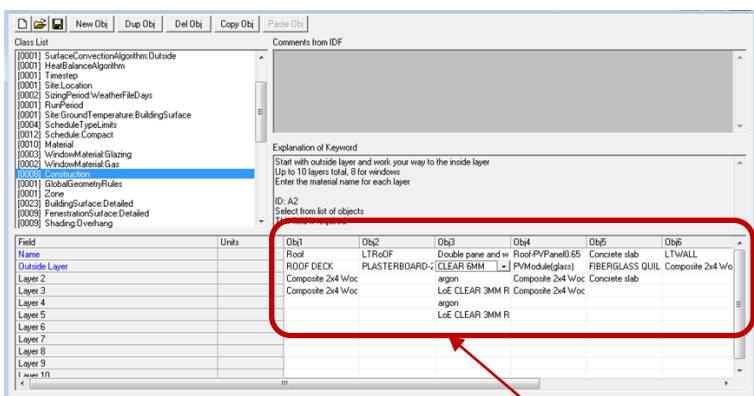

Construction

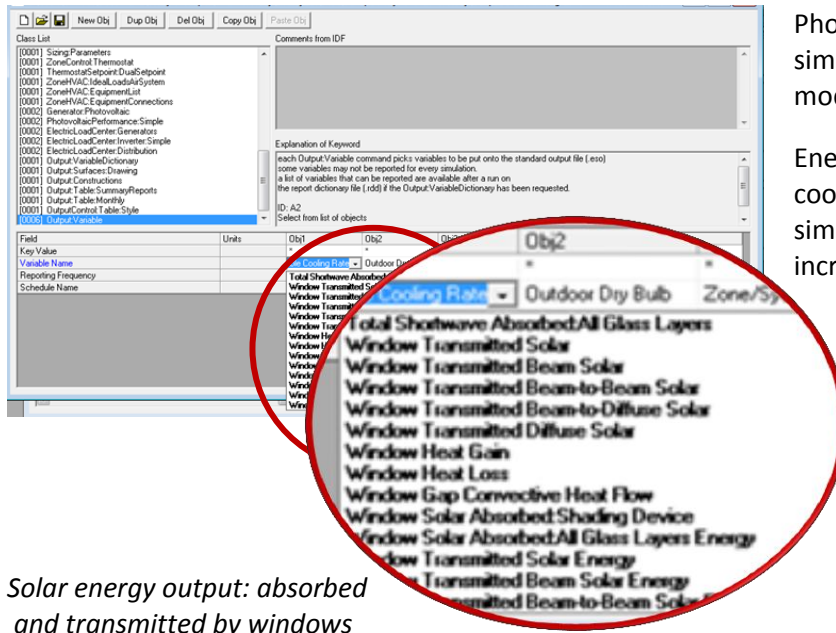

Solar energy output: absorbed and transmitted by windows

Photovoltaic can be simulated using simple modes, or more sophisticated models.

Energy performance: heating and cooling can be determined by using simple HVAC system models, or increasingly detailed system.

2.2.4. Autodesk® Revit® Architecture 2012

The latest version of this Building Information Modelling (BIM) program contains the following tools regarding energy analysis:

1. Solar Studies
2. Conceptual Energy Analysis

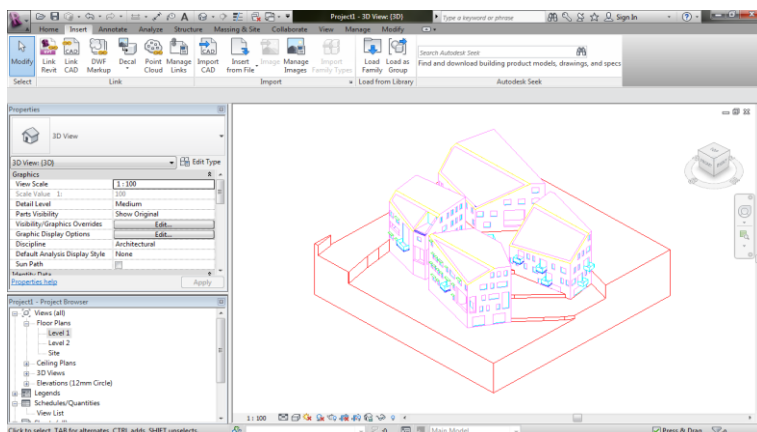

Input

Revit supports the import of CAD files such as DWG, DXF, DGN, SKP, and ACIS SAT files.

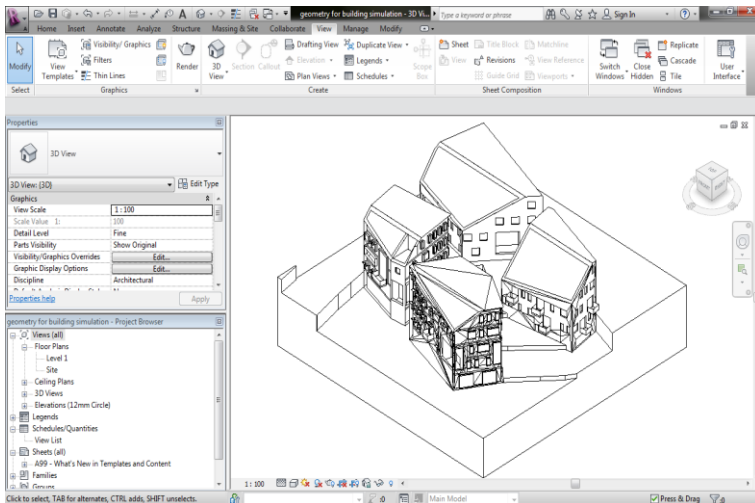

Revit also supports the IFC 2x3 file format.

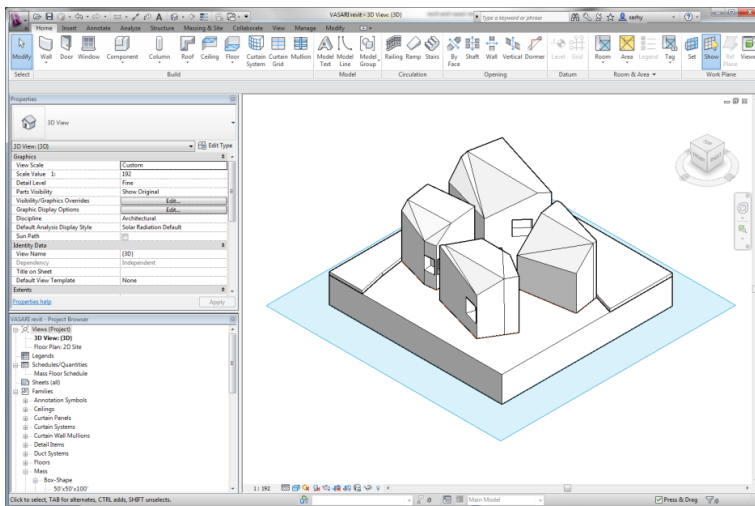

A mass model is required for 2) Conceptual Energy Analysis.

It is made within Autodesk Project Vasari by tracing and extruding from the imported CAD model.

(To save time, the landscape of the simplified model was simplified further in this mass model).

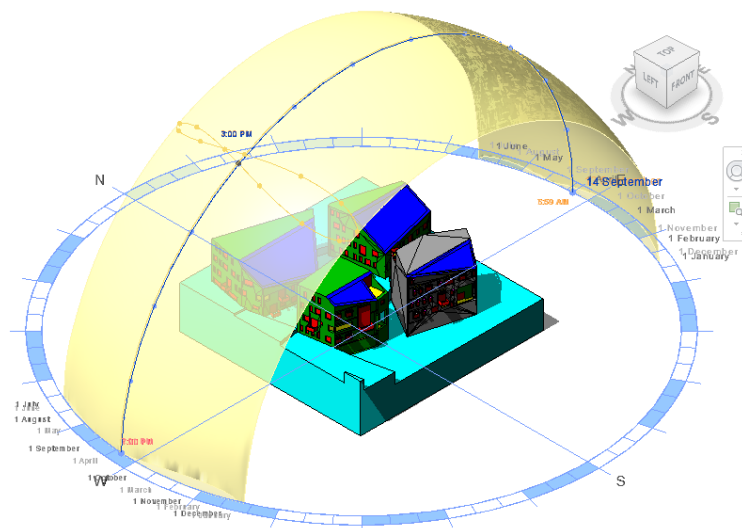

Solar analysis

A sun-path shows how natural light projects shadows onto the buildings due to neighbouring buildings and terrain.

Both CAD and IFC file types can be used.

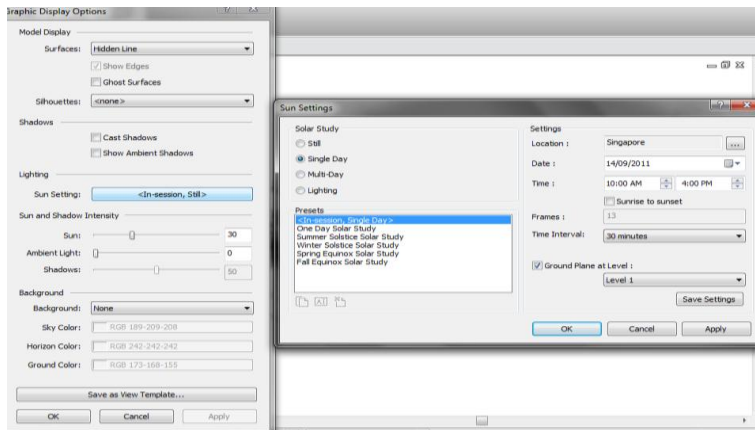

Solar analysis

"Sun settings" of the sun-path can be customized.

Presentation of solar studies, such as shadow intensity, can also be customized (far left).

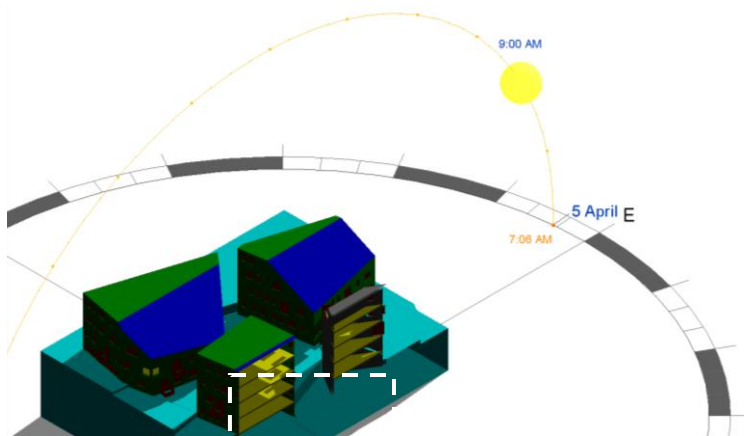

Solar analysis

Using a "section box" to clip a 3D view of the model, the effect of the sun and shadowing in the interior of the buildings can be seen at different times of the year.

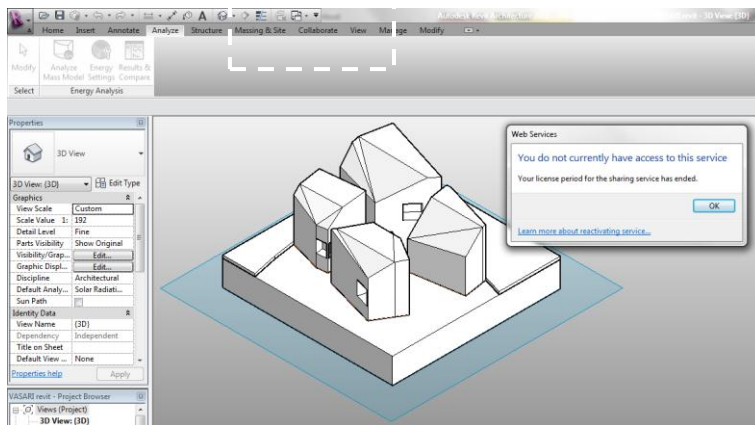

Conceptual energy analysis (CEA)

This feature is found in Autodesk Green Building Studio.

A model consisting of conceptual massing elements (i.e. mass model created by Revit or Vasari) is required.

To analyse the mass model, you need an Autodesk subscription account.

A similar service which does not need log-in access can be found in the review on Autodesk Project Vasari 2.1.

2.2.5. VectorWorks

VectorWorks was launched by Nemetschek as the successor of Minicad. The current version is 2011. VectorWorks can be delivered as a standalone software package, or with the RenderWorks plugin. As a standalone program VectorWorks can be used to generate solar angles for given locations and times, but RenderWorks is necessary for most solar analyses.

With the RenderWorks plugin the program can perform the following analyses:

- Sun/ shade analyses
- Solar animation
- Visualisation of solar installations

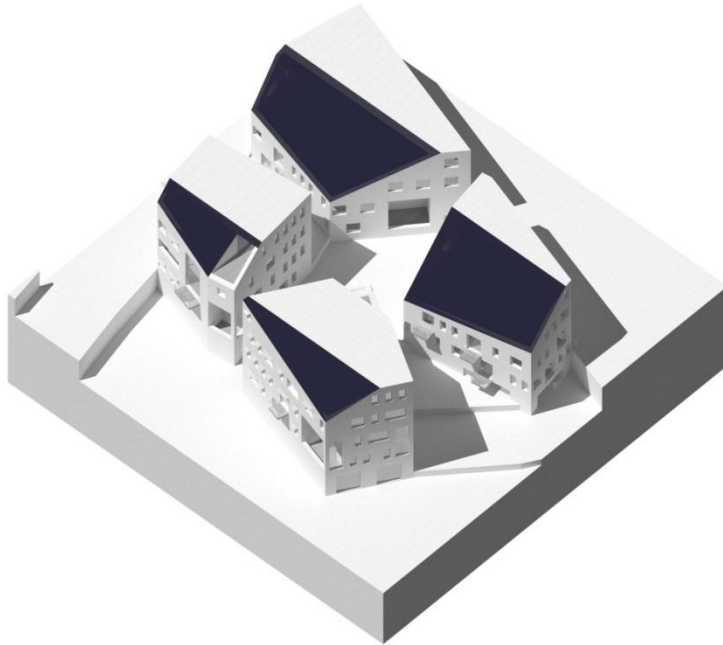

Sun/ shade analysis

By entering the location of the project (longitude and latitude), the date and the time, VectorWorks can generate a sunlight object for any position in the world. Using this object VectorWorks can render correct shadow positions for the given date and time, allowing visual assessment of solar access and shading.

By generating or importing site and landscape data, solar access to the project site as well as overshadowing from surrounding objects can be assessed. Solar access to building surfaces can be modelled in order to determine suitable locations for installation of solar systems, as well as possible design modifications to increase solar access.

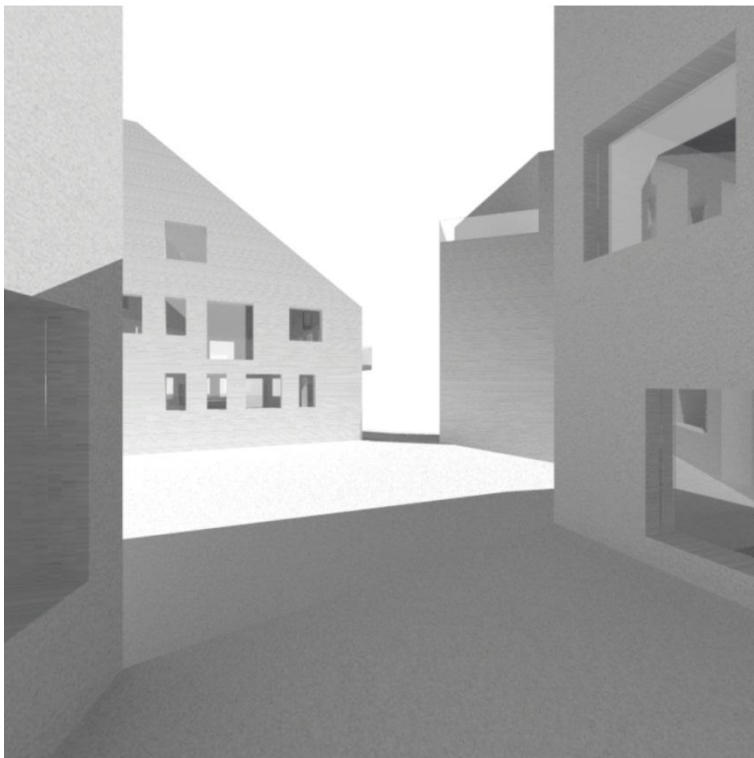

Solar animation

VectorWorks can create a solar animation for a given date and geographical position. The output is generated in a “.mov” file viewable in a stand-alone viewing software. By using an option to print the time on each frame the animation can be used to identify the times of solar access and shading on different points of the project, allowing the user to identify likely positions for solar installations, as well as potential exposure and shading issues.

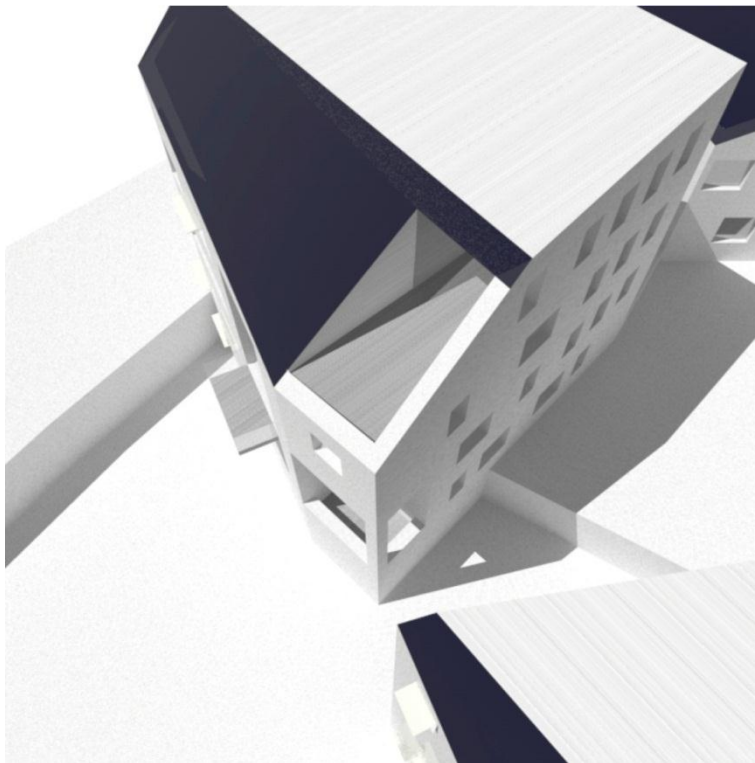

Visualisation of solar installations

By using the RenderWorks plugin, photorealistic representations of solar installations may be created, including simulation of colour, materiality and reflectivity. The VectorWorks libraries do not include premade objects for solar technologies, but a number of 3D file types can be imported, including “.dwg” and “.ifc” formats.

By combining accurately modelled solar components with a solar animation, reflectivity and colour changes in varying lighting conditions can be assessed with a certain degree of accuracy.

It should be noted that all VectorWorks and RenderWorks output is qualitative. The program cannot supply quantitative solar data, e.g. for use in energy or daylighting calculations. VectorWorks does include options to export modelling data to the energy calculation program DOE-2 and lighting software such as Radiance, however this has not been tested in this study.

2.2.6. Autodesk® Ecotect®

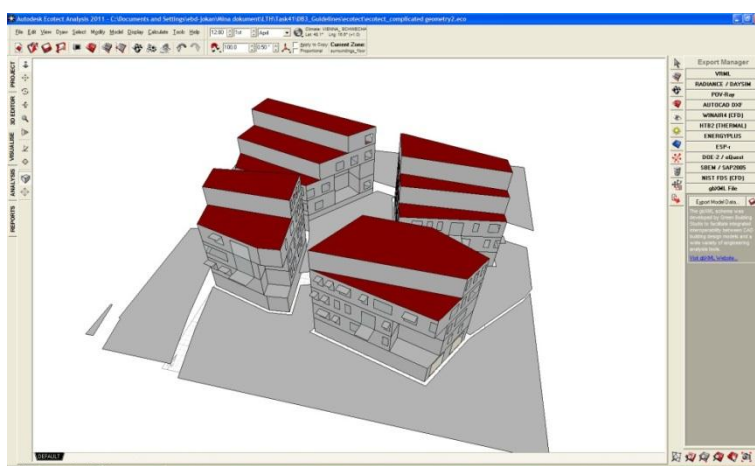

Overview

The program was launched by Autodesk in 2008, the latest version is currently 2011.

Regarding solar energy, the program can perform the following analyses:

1. Solar access analysis
2. Solar exposure
3. Solar envelope
4. Sun-path diagram
5. Lighting analysis
6. Advanced daylighting
7. Thermal analysis

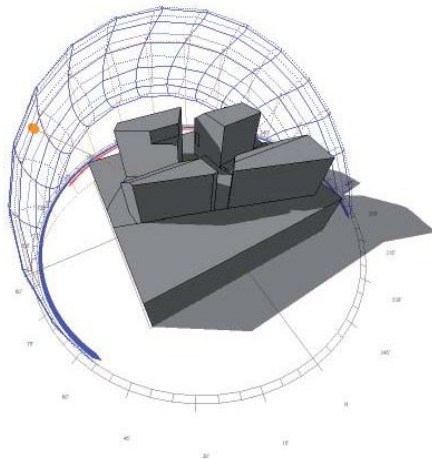

Average daily radiation (Wh/m²), sun-path

OBJECT ATTRIBUTES
Total Radiation
Unit: Wh/m² | 10/10/18 11:00:00
(1) EXTRACT 02

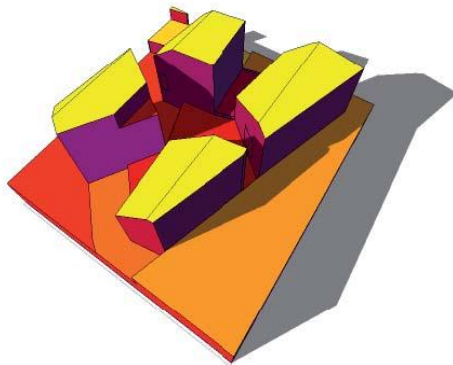

Total Radiation (Wh)

Annual shadow paths

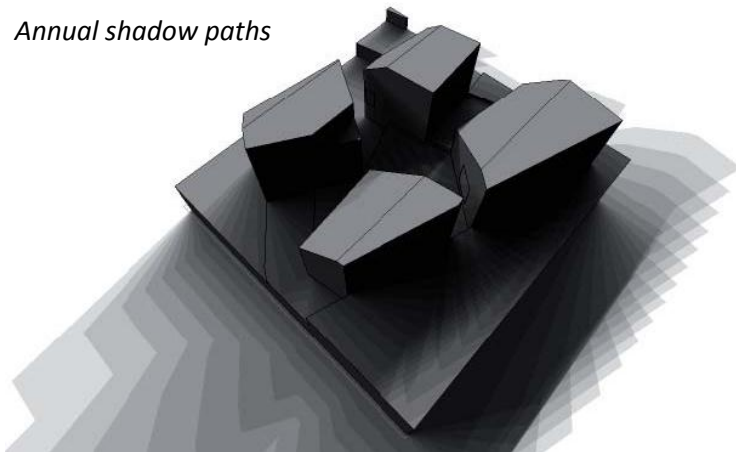

Solar access analysis

Available options:

1. Incident solar radiation
2. Absorbed/ transmitted solar radiation
3. Sky factor & photo-synthetically active radiation
4. Shading, overshadowing and sunlight hours
5. Before and after comparison

There are possibilities to show analysis with different colours, sun-path, etc.

Solar access analysis

Possibilities to perform analyses on a more complex urban geometry.

Solar access analysis

Possibilities to overview annual paths of shadows of (urban) geometry.

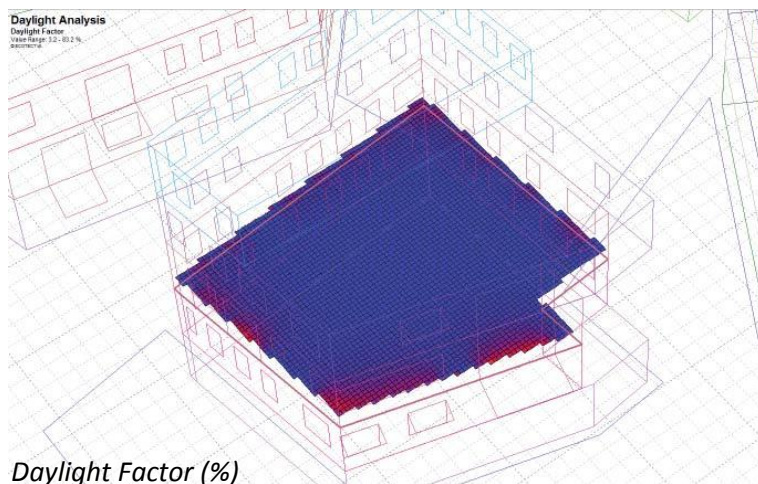

Lighting analysis

Available options:

1. Natural light levels
2. Overall daylight and electric light levels
3. Zone-specific daylight factor values
4. Export options to radiance

Possibilities are available to show analysis with different colours.

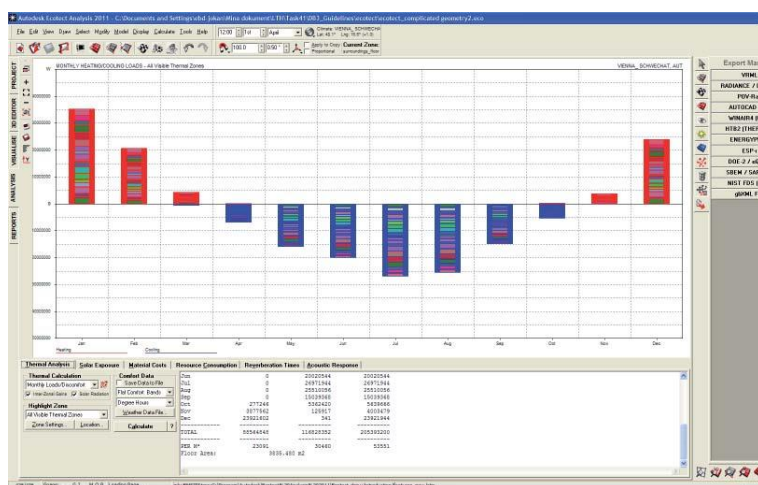

Thermal Analysis

1. Available options: Temperatures
2. Losses and gains
3. Space loads
4. Thermal comfort comparative data

There are possibilities to show analysis with different colours, sun-path etc.

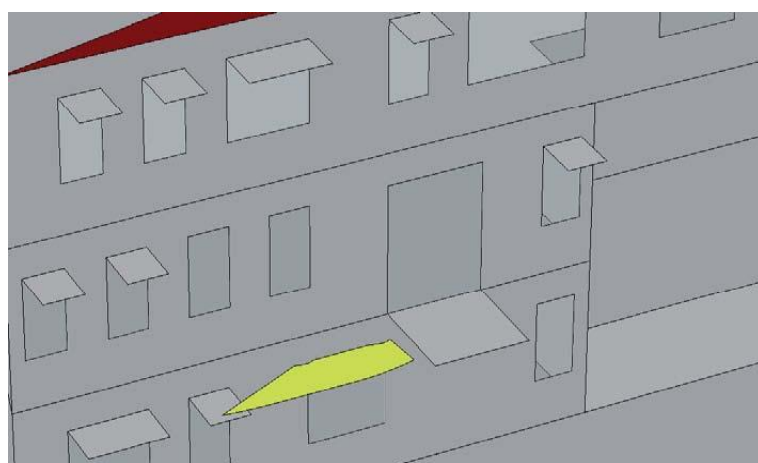

Shading Design

Available options:

1. Project a cutting profile
2. Extrude objects for solar envelope
3. Generate optimised shading device
4. Project solar shading potential

This can be shown within other analyses.

Additional points of interests:

- It is a mainly a surface model program, not a 3D wall model. 3D wall models imported from any of the file formats will be seen as two layers of surfaces, not as one outer wall.

- The import of simple geometry (i.e. mass) works relatively well for all supported and most common formats -3DS, IFC and gbXML. Importing a more complicated geometry (i.e. 3D wall geometric models) will result in a model which is hard to work with. One way of dealing with the problem is by importing the complicated geometry into Ecotect, followed by drawing a surface model within Ecotect itself. However, the program lacks a dynamic reload option; for every change made within another program, the model needs to be exported, and reloaded into Ecotect again.
- Important features in other programs of Autodesk –like layers- cannot be imported into Ecotect. Some of those features could make importing things easier. It could, for instance, be convenient to have all walls in one layer, import it in Ecotect and then apply properties to it.
- Ecotect’s own modelling possibilities are relatively limited. Basically, thermal zones are constructed within the program, not ‘architectural zones’. The graphical user interface is totally different from the one in –for instance- Autodesk AutoCAD, something which requires an adaptation for first time users.
- A lot of aspects of solar integrated architecture can be simulated within Ecotect. Some simulations require a lot of (technical) knowledge and experience (mainly the thermal analysis and all lighting analyses), others are relatively easy to understand and self-explanatory (solar exposure, sun-path diagrams, shadow ranges, shading design).
- It is possible to add own materials to a model. The default materials have a relatively low standard which are mostly based on American building methods. HVAC systems are harder to modify and require advanced technical knowledge. The setup of the zones can be synchronised according to UK building regulation standards.
- Ecotect has an extensive selection of export options. The Radiance program can be installed parallel in order to generate more precise lighting analysis.

2.2.7. Autodesk® Project Vasari 2.1

The latest Project Vasari 2.1 technology preview was released on Sept 7, 2011. It is undergoing trials at Autodesk Labs and is available, at the time of this report’s publishing time, as a free download at http://labs.autodesk.com/utilities/vasari/term_and_condition/

Project Vasari can be called a "Lite version of Revit", having a similar interface and platform, but without the detailed BIM modelling tools in Revit. Files from the latest Revit 2012 can be opened in Project Vasari 2.1 and vice versa. Project Vasari contains the following tools regarding energy analysis:

1. Solar studies: sun-path and settings help to show shadows and daylight effects on the buildings and terrain on site. Animations are possible for single-day or multi-day solar studies. It is also possible to vary brightness of direct light and ambient light.
2. Solar radiation analysis: to study incident solar radiation on selected building surfaces. It is best for studying shadowing effects and not recommended for sizing PV panels. It allows performing analyses on a more complex urban geometry.
3. Conceptual energy analysis: can be used to create an energy model, specify floors and thermal zones to the building mass(es) and adjust basic energy settings (e.g. building type) and optional energy settings (e.g. target percentage glazing). The energy analysis is accessed via (free) subscription to the Autodesk web service. Results can be exported in “.pdf”. The energy model can be exported in “.gbxml” for further analysis in other third party programs.

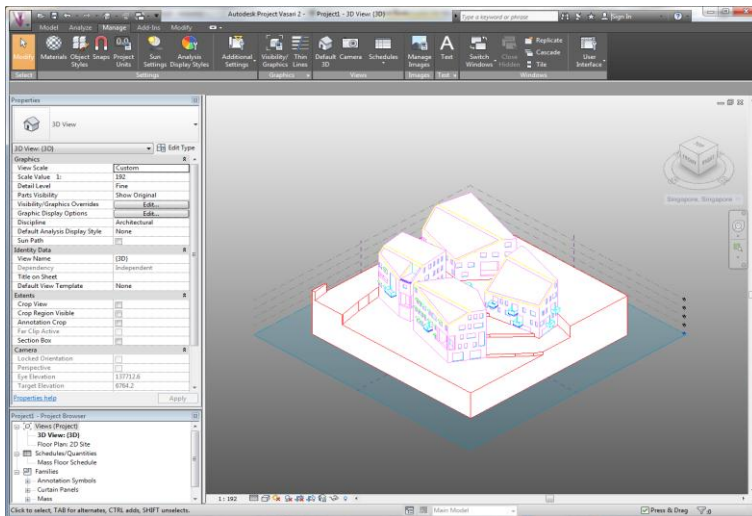

Preparing the model for solar analysis

Project Vasari supports the import of CAD files such as “.dwg”, “.dxf”, “.dgn”, “.skp” and ACIS SAT files. It does not support the import of IFC files.

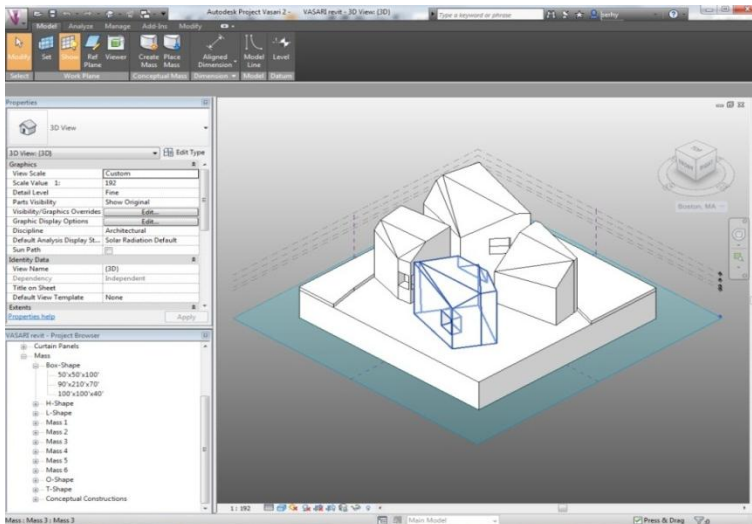

A mass model is required for 2) Solar Radiation Feature and 3) Conceptual Energy Analysis.

It is made within Project Vasari by tracing and extruding from the imported CAD model.

(To save time, the landscape of the simplified model was simplified further in this mass model).

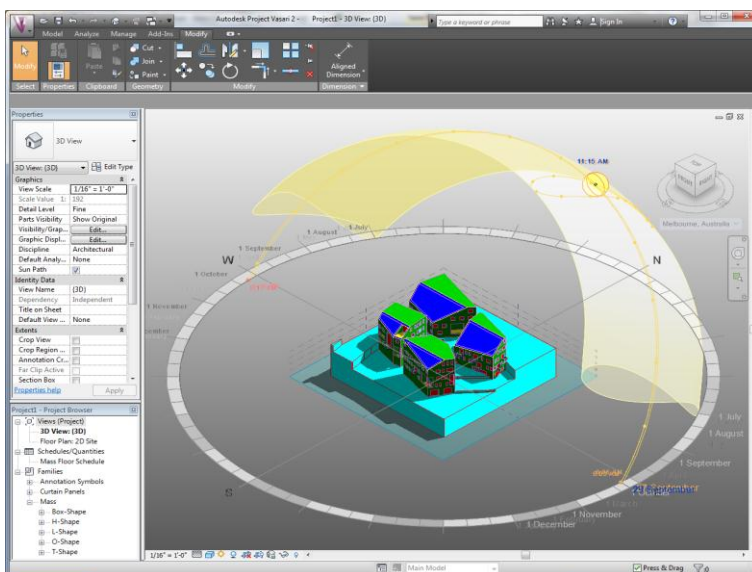

Solar study

A sun-path shows how natural light projects shadows onto the buildings due to neighbouring buildings and terrain.

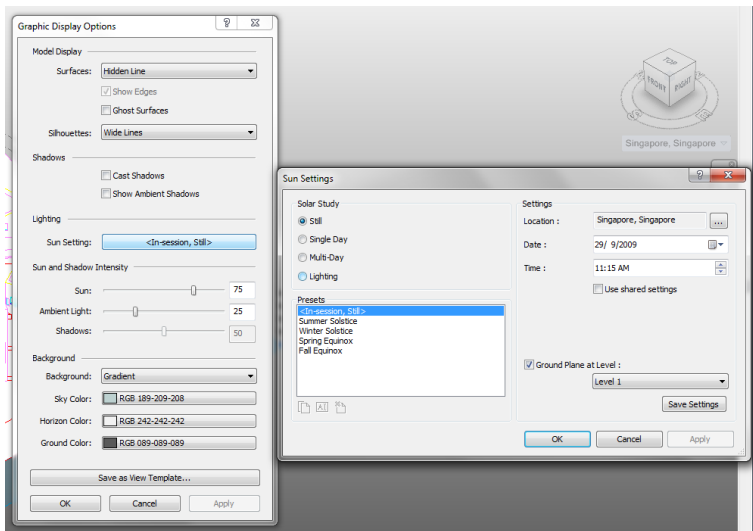

Solar study

"Sun settings" of the sun-path can be customized.

Presentation of solar studies, such as shadow intensity, can also be customized (far left).

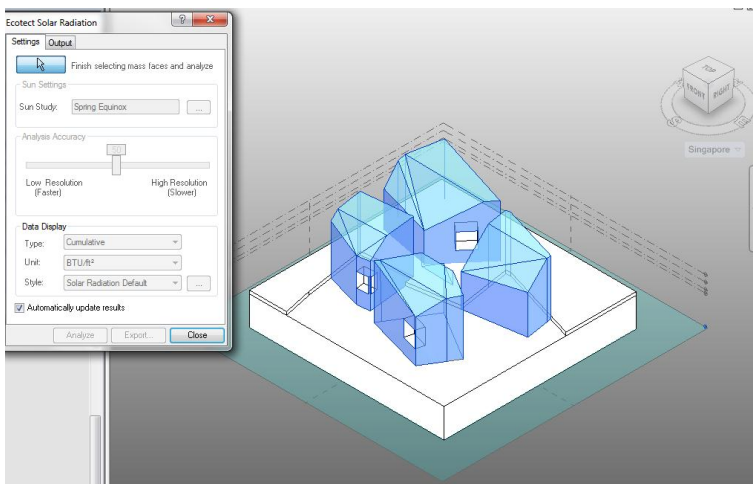

Solar radiation analysis

This feature is found in Autodesk Ecotect.

A model consisting of conceptual massing elements (i.e. mass model created by Revit or Vasari) is required.

Mass faces for solar radiation analysis are selected.

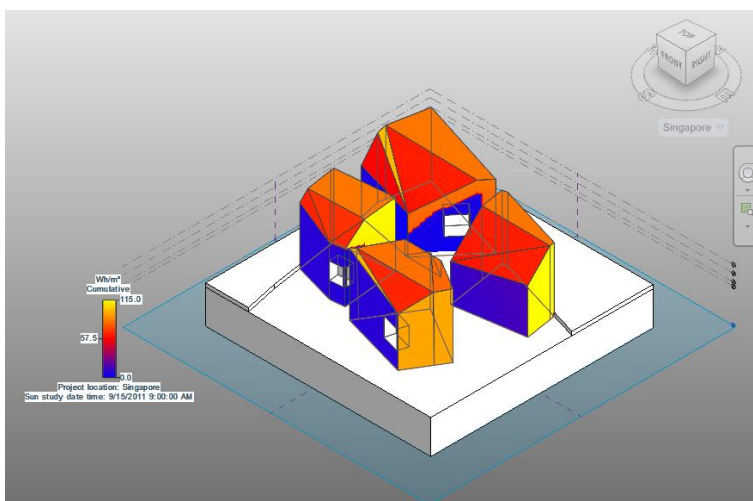

Solar radiation analysis

There are 3 solar radiation options: cumulative values, average mean of hourly values, and peak maximum value, calculated during the study period.

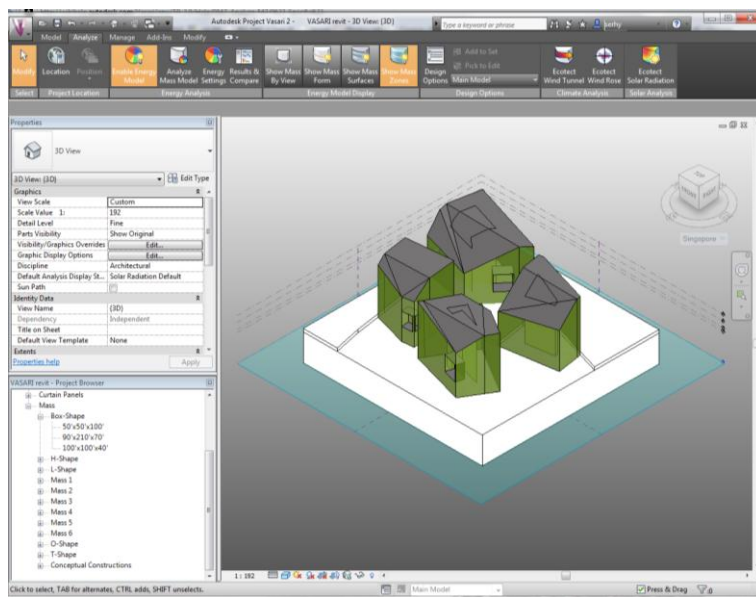

Conceptual energy analysis (CEA)

This feature is found in Autodesk Green Building Studio.

A model consisting of conceptual massing elements (i.e. mass model created by Revit or Vasari) is required.

The program determines "mass zones" within the model.

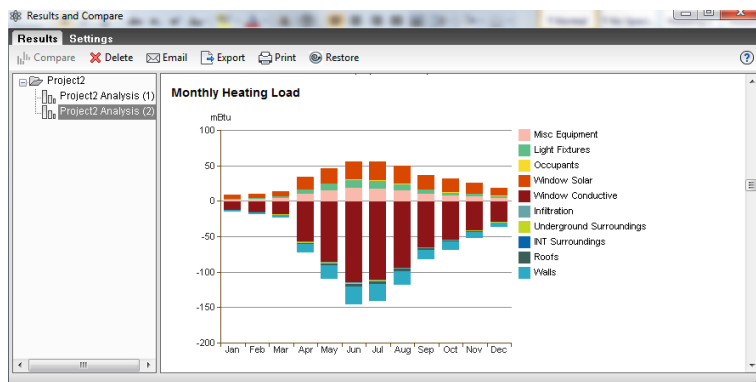

Conceptual energy analysis (CEA)

Output: an energy chart from the CEA showing that heat loss from window conduction contributes most to the heating demand, while window solar transmittance reduces most heating demand.

Building Performance Factors

Location:	Singapore
Weather Station:	1451726
Outdoor Temperature:	Max: 36°C/Min: 24°C
Floor Area:	1,019 m ²
Exterior Wall Area:	4,012 m ²
Average Lighting Power:	10.87 W / m ²
People:	36 people
Exterior Window Ratio:	0.00
Electrical Cost:	\$0.14 / kWh
Fuel Cost:	\$0.78 / Therm

Energy Use Intensity

Electricity EUI:	174 kWh / sm / yr
Fuel EUI:	12 MJ / sm / yr
Total EUI:	640 MJ / sm / yr

Life Cycle Energy Use/Cost

Life Cycle Electricity Use:	5,533,227 kWh
Life Cycle Fuel Use:	392,657 MJ
Life Cycle Energy Cost:	\$355,528

*30-year life and 6.1% discount rate for costs

Renewable Energy Potential

Roof Mounted PV System (Low efficiency):	181,345 kWh / yr
Roof Mounted PV System (Medium efficiency):	362,690 kWh / yr
Roof Mounted PV System (High efficiency):	544,035 kWh / yr
Single 15' Wind Turbine Potential:	150 kWh / yr

*PV efficiencies are assumed to be 5%, 10% and 15% for low, medium and high efficiency systems

Conceptual energy analysis (CEA)

To analyse a mass model, an Autodesk subscription account is needed.

Some of the CEA analysis results can be seen on the left. The rest of the analysis topics are:

- Mass
- Building performance factors
- Energy use intensity
- Life cycle energy use and cost
- Renewable energy potential
- Annual carbon emissions
- Annual energy use / cost
- Energy use: fuel
- Energy use: electricity
- Monthly heating load
- Monthly cooling load
- Monthly fuel consumption
- Monthly electricity consumption

- Monthly peak demand
- Annual wind rose
- Monthly design data
- Annual temperature bins
- Diurnal weather averages
- Humidity

Limitations

Autodesk Project Vasari is still in its beta version, so at this time (spring 2012) there are concerns about bugs in the software and accuracy of its numerical (quantitative output). Using it as a qualitative assessment and comparison between different design options at the early design stage may provide satisfactory results.

2.2.8. RETScreen® International

RETScreen is a tool available for free and developed by Natural Resources Canada. RETScreen is a Microsoft Excel based application that evaluates the energy production and savings, costs, emission reductions, financial viability and risk for various types of renewable energy and energy efficient technologies. The tool includes climate databases from the NASA. This versatile tool covers a wide range of systems for the production of heat, cold and electricity, and for the evaluation of various energy efficiency measures. Among these functions, RETScreen is used in this work to size a solar system to produce domestic hot water.

The screenshot displays the RETScreen International software interface. The top header includes the Natural Resources Canada logo and the text 'RETScreen® International www.retscreen.net Clean Energy Project Analysis Software'. The main content area is divided into two sections: 'Project information' and 'Site reference conditions'. The 'Project information' section contains fields for Project name (Hot domestic water), Project location (Austria), Prepared for (DB3), Prepared by (Emilie Bouffard), Project type (Heating), Technology (Solar water heater), Analysis type (Method 2), and Heating value reference (Higher heating value (HHV)). The 'Site reference conditions' section contains a field for Climate data location (Vienna/Schwechat). Red arrows and numbers 1, 2, and 3 point to the Project type, Technology, and Climate data location fields respectively. A legend on the right side of the interface lists: 1. Project, 2. Method of analysis, and 3. Climate and location. The bottom of the interface features logos for NASA, UNIP, GEF, and reeap, along with the text 'Complete Energy Model sheet' and '© Minister of Natural Resources Canada 1997-2009'.

Overview

The first step is to set the project's specifications

RETScreen Energy Model - Heating project

Heating project

Technology: Solar water heater

Lead characteristics: Application: Swimming pool, Hotwater

Unit: Base case, Proposed

Load type: Apartment

Number of units: 1

Occupancy rate: 0

Daily hot water use - estimated: 19,000 L/d

Daily hot water use: 95 C

Temperature: 7 d

Operating days per week: 7

Percent of month used: Formula

Supply temperature method: C

Water temperature - minimum: 13.7 C

Water temperature - maximum: 60 C

Heating: Unit: Base case, Proposed case, Energy saved, Incremental initial costs

Resource assessment: Solar tracking mode: Fixed

Slope: 45.0

Azimuth: 0.0

Show data: Solar water heater

Type: Glazed

Manufacturer: Thermo Dynamics

Model: S32-P

Gross area per solar collector: 2.36 m²

Aperture area per solar collector: 2.78 m²

FR (tau alpha) coefficient: 0.64

FR (L) coefficient: 4.65

Temperature coefficient for FR (L): -0.000 (W/m² C)

FR (U) coefficient: 4.65 (W/m² C)

Temperature coefficient for FR (U): -0.000 (W/m² C)

Number of collectors: 11

Solar collector area: 29.60 m²

Capacity: 19.45 kW

Miscellaneous losses: 4.00%

Balance of system & miscellaneous: Storage: No

Heat exchanger: No

Miscellaneous losses: 0.00%

Pump power / solar collector area: 0.00 W/m²

Electricity rate: 0.100 \$/kWh

Summary: Electricity - pump: 0.0 MWh

Heating delivered: 22.0 MWh

Solar fraction: 10%

Heating system: Project verification: Base case, Proposed

Fuel type: Natural gas

Seasonal efficiency: 70%

Fuel consumption - annual: 27,883.6 m³

Fuel rate: 0.400 \$/m³

Fuel cost: 11,352 \$

The second step is to set the energy model tab. The data assumed are:

- The inclination of panels to 35° which is the optimum slope for the year for Vienna (according to Photovoltaic Geographical Information System, European commission, JRC);
- The number of people who influence the demand for the hot water;
- The type of system chosen from what is available in Austria;
- Minimum and maximum temperature of the initial water (in °C) and the final temperature to achieve (60°C).

RETScreen Cost Analysis - Heating project

Settings: Method 1, Method 2, Notes/Range, Second currency, Cost allocation

Initial costs (credits):

Item	Unit	Quantity	Unit cost	Amount	Relative costs
Feasibility study	cost			\$ -	0.0%
Development	cost			\$ -	0.0%
Engineering	cost			\$ -	0.0%
Solar water heater	cost			\$ 15,800	100.0%
Balance of system & miscellaneous				\$ -	0.0%
Spare parts	%			\$ -	
Transportation	project			\$ -	
Training & commissioning	cost			\$ -	
Contingencies	%			\$ 15,800	100.0%
Interest during construction	%			\$ -	0.0%
Total initial costs				\$ 15,800	100.0%

Annual costs (credits):

Item	Unit	Quantity	Unit cost	Amount
Parts & labour	project			\$ -
Contingencies	%			\$ -
Fuel cost - proposed case	m ³	29,455	0.400	\$ 11,382

Annual savings:

Item	Unit	Quantity	Unit cost	Amount
Fuel cost - base case	m ³	37,883	0.400	\$ 15,157

Periodic costs (credits):

Item	Unit	Year	Unit cost	Amount
End of project life	cost			\$ -

The next step is to set the cost analysis tab. The data assumed are:

- Electricity price (in \$/kWh);
- An inflation rate of 2.5 %;
- Price system estimated (in \$)
- Grants (in \$)

Results

The results of computation will show the ideal number of solar panels. The results will also indicate the optimal storage volume.

Limitations

RETScreen does not provide a 3D interface. Its import and export options are limited to the same as in Excel. However, all data which describe the project have to be entered by users. RETScreen cannot deal with more than one building at the time.

2.2.9. Radiance

Radiance is a suite of programs for the analysis and visualization of lighting in design. It is a physically based, backward ray tracing rendering tool which means that light rays are traced in the opposite direction to that which they naturally follow (starts from the eye to the light sources taking into account all physical interactions with the surfaces of the objects composing the scene) (Dubois, Horvat et al., 2010). The calculations are based on the site definition (latitude and longitude) and on the sky definition (different CIE sky models are implemented in Radiance). Radiance is a free tool which is open source and provides complete freedom on the use, development and distribution of the source code and executable with the objective to increase the number of users that can benefit from his capabilities (Radiance, 2002). Radiance algorithms are actually within Ecotect, DAYSIM and IES VE for instance.

Calculated values included the radiance, luminance, irradiance, illuminance (in three channels) and glare indices. Simulations results may be displayed as colour images with different contour plots and numerical values. It is also a valuable program for estimating the incoming or incident irradiation on a generic surface or volume.



Step 1-Setting the views

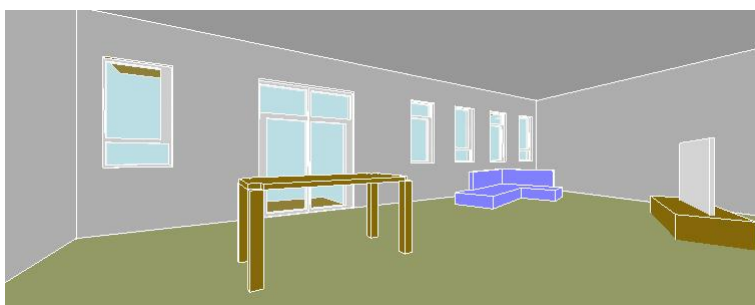

Ecotect, view 1

Ecotect, view 2

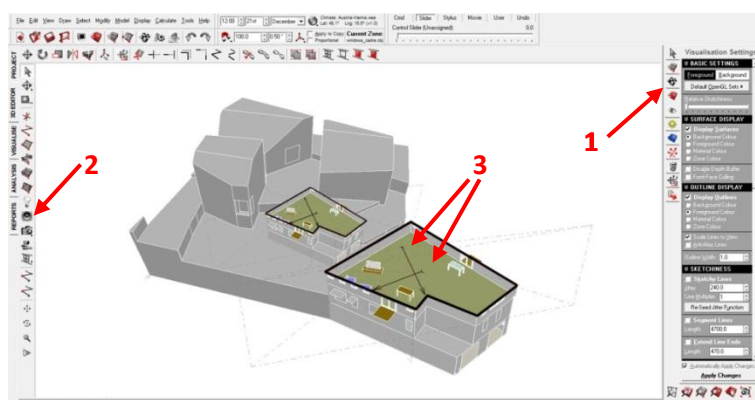

Setting the views (Source: Ecotect)

1. Materials Assignments tab
2. Camera Interactively
3. Position of the views

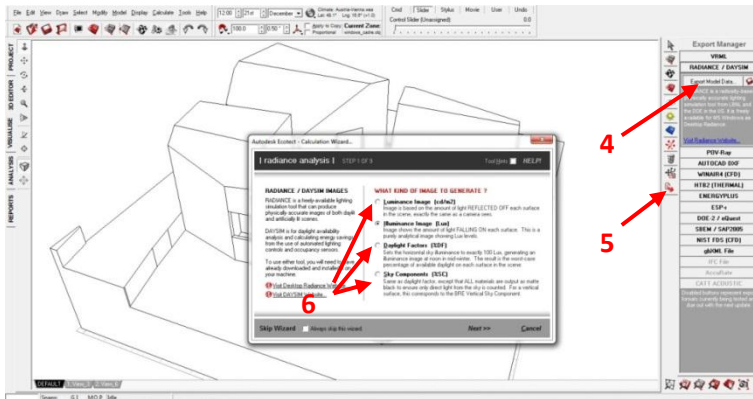

Rendering (Source : Ecotect-Radiance)

4. Export Manager tab
5. Export to Radiance
6. Values



Simulation results displayed as colour images with different contour plots

Illuminance image with view 1 (lux), December 21, 12h00 (Source: Ecotect-Radiance), 3hrs.

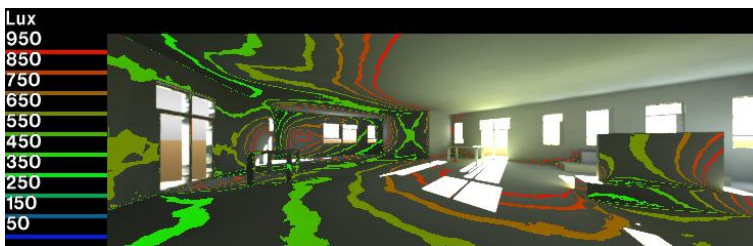

Illuminance image *Contour bands* with view 1 (lux), December 21, 12h00 (Source: Ecotect-Radiance).

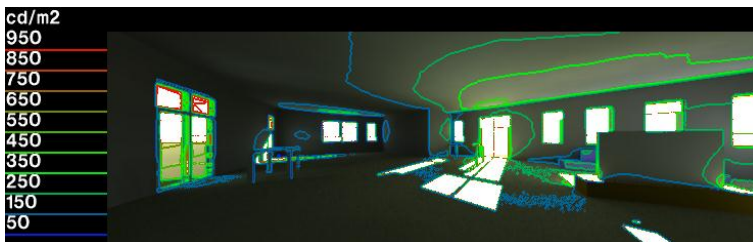

Illuminance image *Contour lines* with view 1 (lux), December 21, 12h00 (Source: Ecotect-Radiance).



Luminance Image with view 2 (cd/m^2), December 21, 12h00 (Source: Ecotect-Radiance), 3hrs.

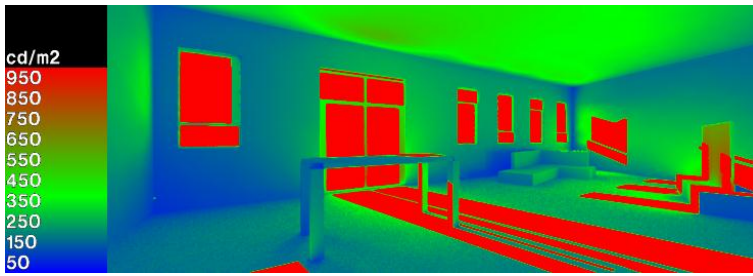

Luminance Image False Color with view 2, December 21, 12h00 (Source: Ecotect-Radiance).



Illuminance views (lux), December 21, 12h00 (Source: Ecotect-Radiance).

Luminance views (cd/m^2), December 21, 12h00 (Source: Ecotect-Radiance).

Simulation results displayed as colour images with different contour plots (Contour lines, Contour bands, False Color).

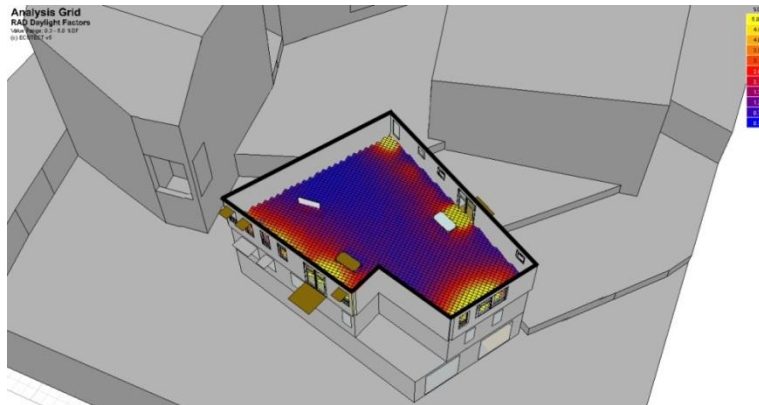

RAD Daylight Factors (Source: Ecotect-Radiance), 5 min.

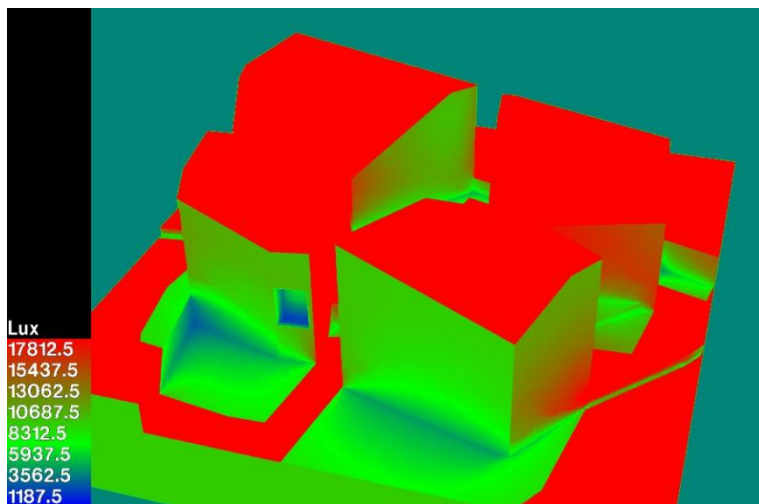

Exterior view (Source: Ecotect-Radiance), 5 min.

Limitations

Radiance is a program primarily aimed at illumination studies and does not include algorithms for the calculation of passive solar heat gains or sizing PV or ST systems.

2.2.10. IES VE

The Virtual Environment tool, by Integrated Environmental Solutions, has been around for many years; the current version is 6.4.0.5. Essentially it consists of several different software (modules) combined into one that can utilize the same geometrical model and exchange some data between these modules. A lot of functionality of the suite requires that multiple modules are used to feed results to each other.

Geometry can be designed within the software or be imported using

- gbXml-files
- dxf-files
- Revit-Link
- SketchUp-Link.

If the building only exists in 2D or the geometry is too complicated, it is recommended modelling it in SketchUp and then importing it to VE.

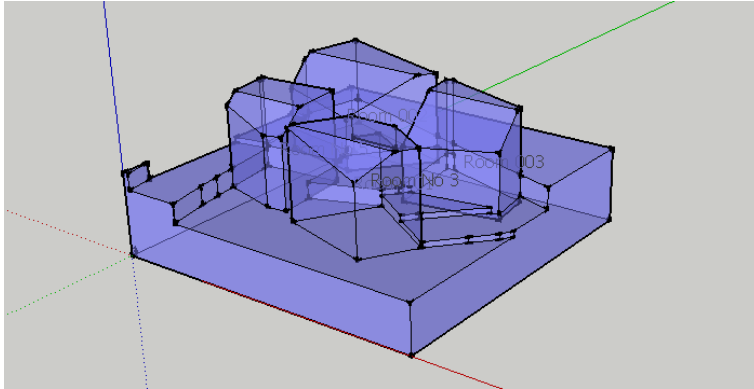

Importing issues

Depending on the quality and complexity of the provided geometry, different methods are used and different results are produced while importing.

The simplified model, drawn in SketchUp (left), ready for import to VE.

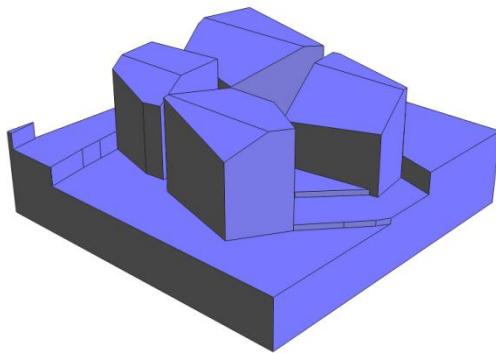

Importing simplified models from SketchUp to VE works without problems, as can be seen in this figure on the left: 3D model in VE, ready for simulation.

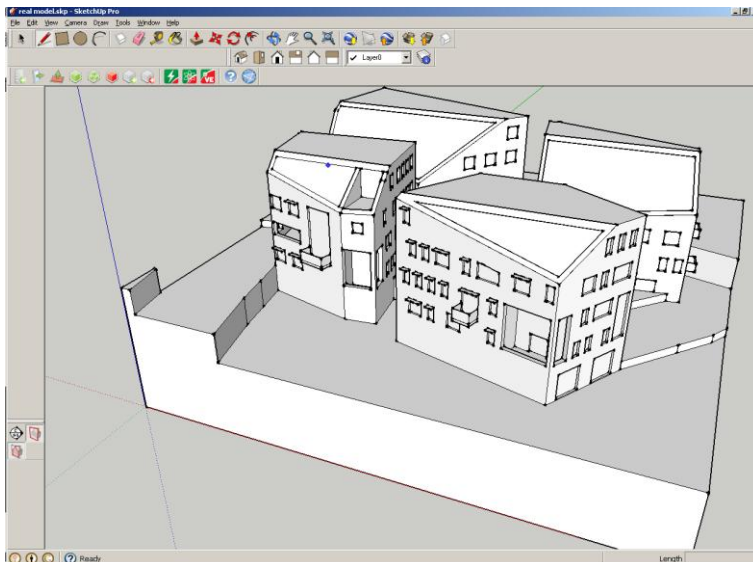

However, when a more detailed model is opened in SketchUp, such as the one on the left, the geometry proves too complicated for the SketchUp export and SketchUp freezes.

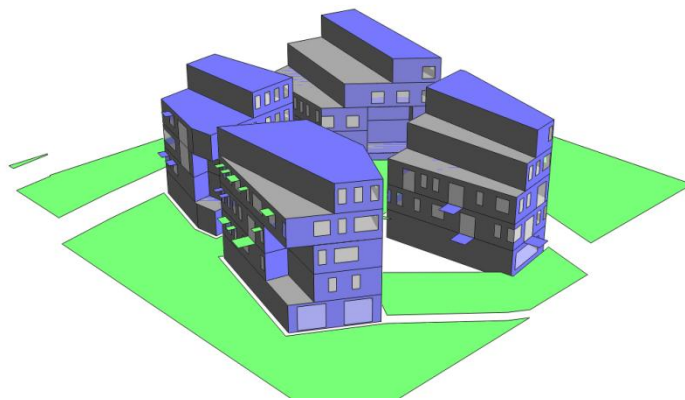

gbXml-import in VE

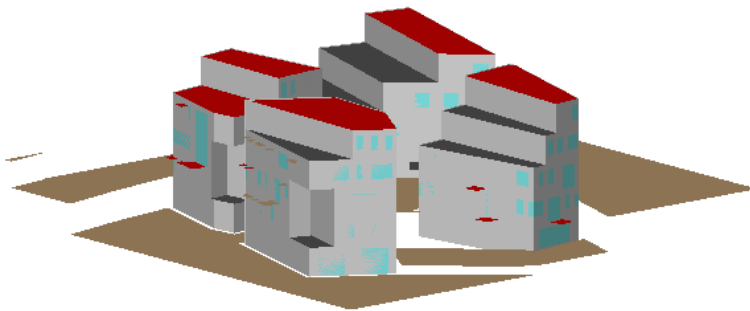

gbXml-file in a gbXml-file viewer

This image represents a more detailed model, when an original gbXml-file is imported into VE.

However, although many details are preserved, they are only in orthogonal grid. All the sloped surfaces (such as roofs and terrain) are lost.

This is explained by the fact that the export to the gbXml-format had problems with the sloped surfaces, as can be seen when the file is opened in a gbXml-viewer (on the left).

This is not a limitation in the gbXml-format. VE can import gbXml-files with sloped surfaces created in Revit for example. However, it is the communication between SketchUp and VE that seems to be limited.

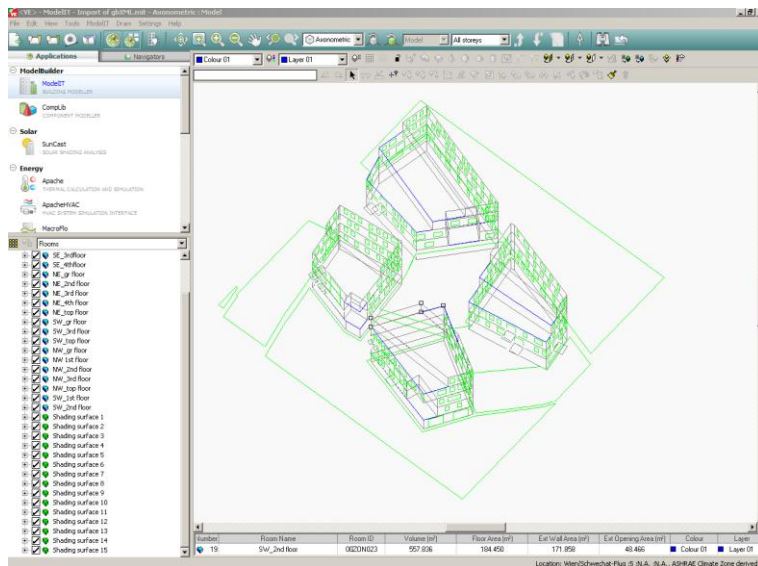

Software evaluation

When it comes to solar energy, VE can perform the following analyses:

- External solar analysis
- Light analysis
- Thermal analysis

Note: for the performed calculations demonstrated here, the model imported from the gbXml-file is used.

Suncast image:
View time = 15 Jun 16:00
Site Latitude = 48.10
Longitude diff. = 1.60
Model Bearing = 0.00
Sun: azi = 265.65 alt = 35.93
Eye: azi = 140.00 alt = 40.00

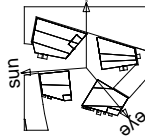

External solar analysis

The external solar analysis performed in the SunCast module.

This module calculates solar gains for the thermal simulation modules.

The user can also create solar animations or images seeing how different buildings get shaded at different times during the year. Such an image can be seen in this figure on the left.

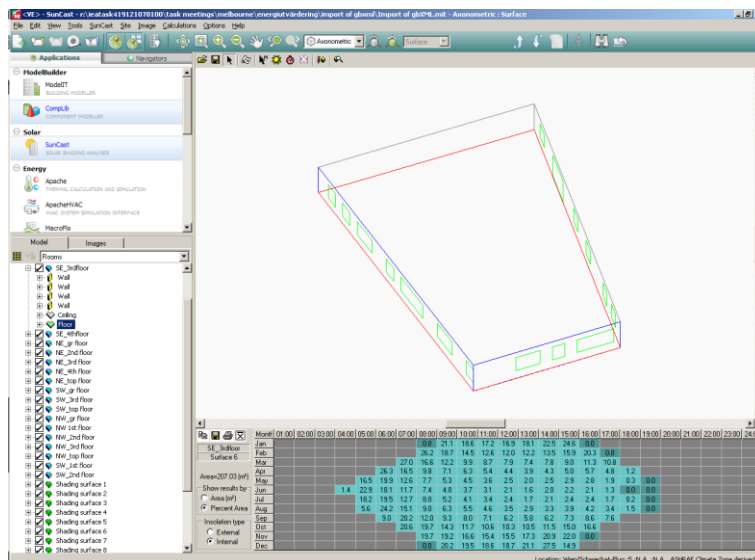
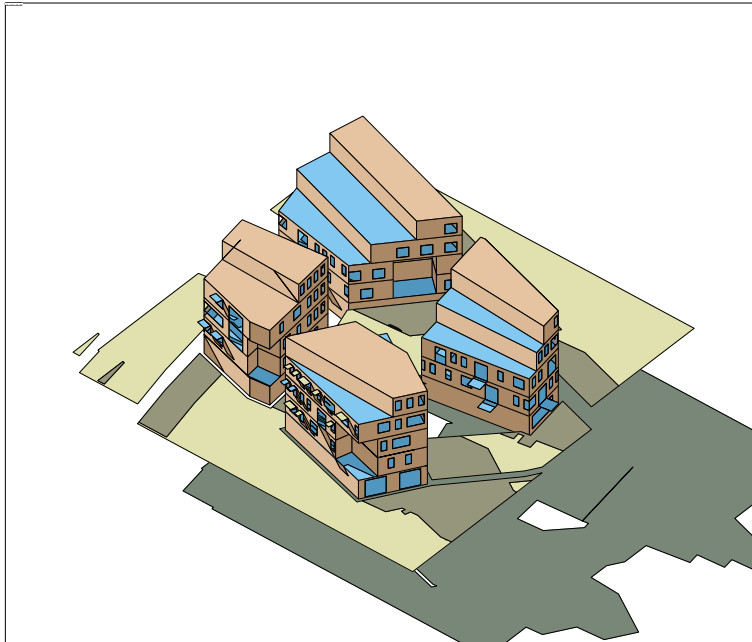

Furthermore, the user can look at what times a surface has direct sunlight covering it and to what percentage.

These results are fed into the thermal modules for the thermal analysis of the buildings.

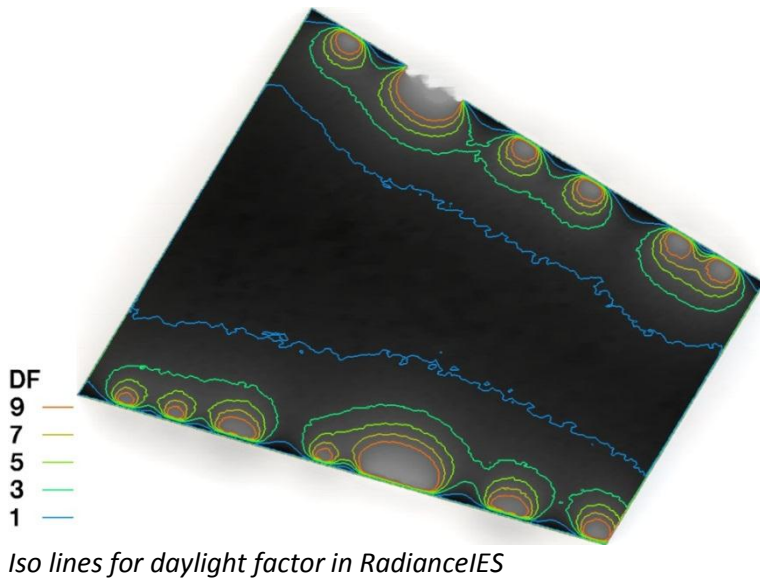

Light analysis

VE contains several light-calculation modules. The one used here is RadianceIES. It uses the Radiance algorithms to calculate the luminance and illuminance. It can also calculate glare.

In the figure on the left, a calculation of daylight factors from the provided geometry can be seen.

Another useful feature is that sensors can be placed in rooms to enable daylight dimming in the thermal analyses.

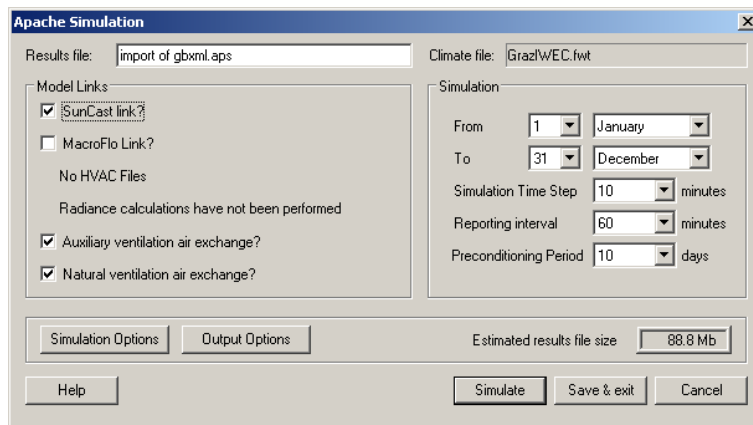

Thermal analyses

As stated earlier, the thermal module can make use of results generated in other modules. This can be seen on the left hand side where the model links are.

The thermal simulation is really one of VEs strongest sides. This is where all results regarding energy are calculated and presented, such as solar insolation on surfaces, into rooms, temperatures on surfaces and so on. There are also a lot of options for room grouping, thermal templates etc. This makes the software capable of handling huge models with thousands of thermal zones without effort from the user.

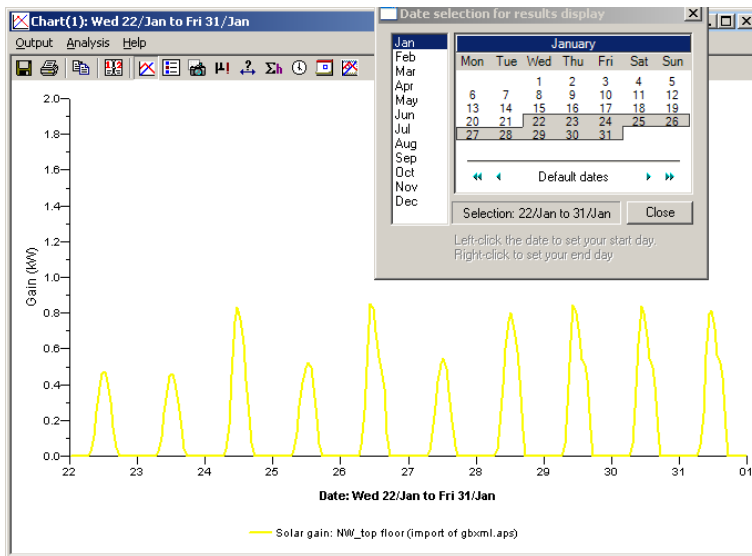

The results can be combined in all kinds of ways. Viewed in graphs or tables etc. A typical graph view can be seen in the figure on the left. The results can also be exported to Excel for example.

Result view in VE. In this case solar gain into one of the thermal zones

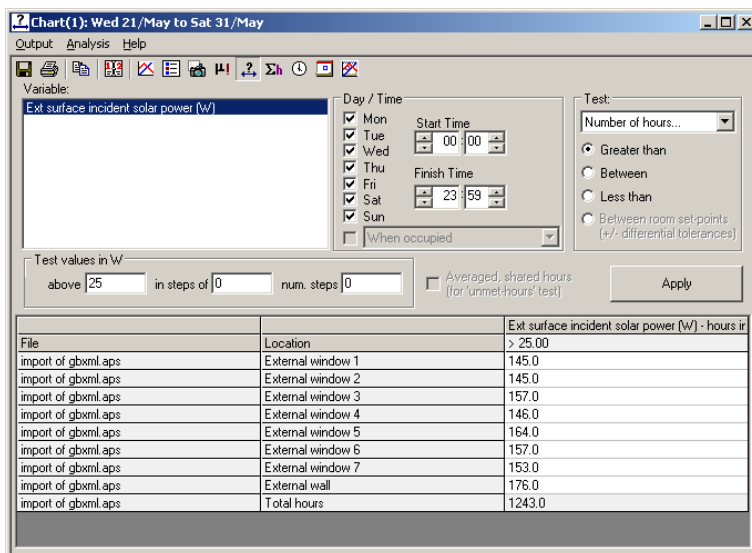

The user can immediately get mean, maximum and minimum values or do range tests.

For example: for how many hours is the incident solar power above 25 W on this wall?

2.2.11. SolarBILANZ

With the development of the solar balance tool (German: “Solarbilanz Tool”), a planning tool has been created which assists building designers in the early planning phase to pre-estimate the expected gains, area required and costs of different solar technologies. The primary target group is architects who will be enabled, without any great efforts or specific technical knowledge, to carry out the planning of solar and photovoltaic systems.

The tool has been designed as technology-neutral, not offering any choice for a specific type of Solar/PV-module. The reachable gains have to be entered manually according to the scales generally indicated by the manufactures. Thus, the tool will be easily applicable to future higher efficiency gains or technological developments.

Under the premise to be a simple tool for a rapid assessment of the implementation of solar thermal and photovoltaic systems, the solar balance tool is subject to certain limitations regarding the precision of the potential and cost calculations. Although the manual entry of measured or estimated data allows for a precise calculation, quite often in the early planning phase detailed information is not yet available. So, primarily, the tool can support planners in the design process to make initial estimations. Later on experts may be consulted for more detailed calculations.

The Solarbilanz tool is Excel based, available only in German, and currently released for download: <http://www.energyagency.at/fileadmin/aea/pdf/Gebaeude/Solarbilanztool.xls>

Presented in Figure 4, the primary functions of SolarBILANZ are:

- Calculation of heating and hot water consumption
- Calculation of power consumption
- Calculation of solar heat and photovoltaic potential
- Calculation of CO₂ emissions and primary energy consumption
- Calculation of life-cycle costs.

Furthermore, the tool also provides:

- Calculation of investment costs
- Calculation of external costs (presented in Figure 5, p.52).

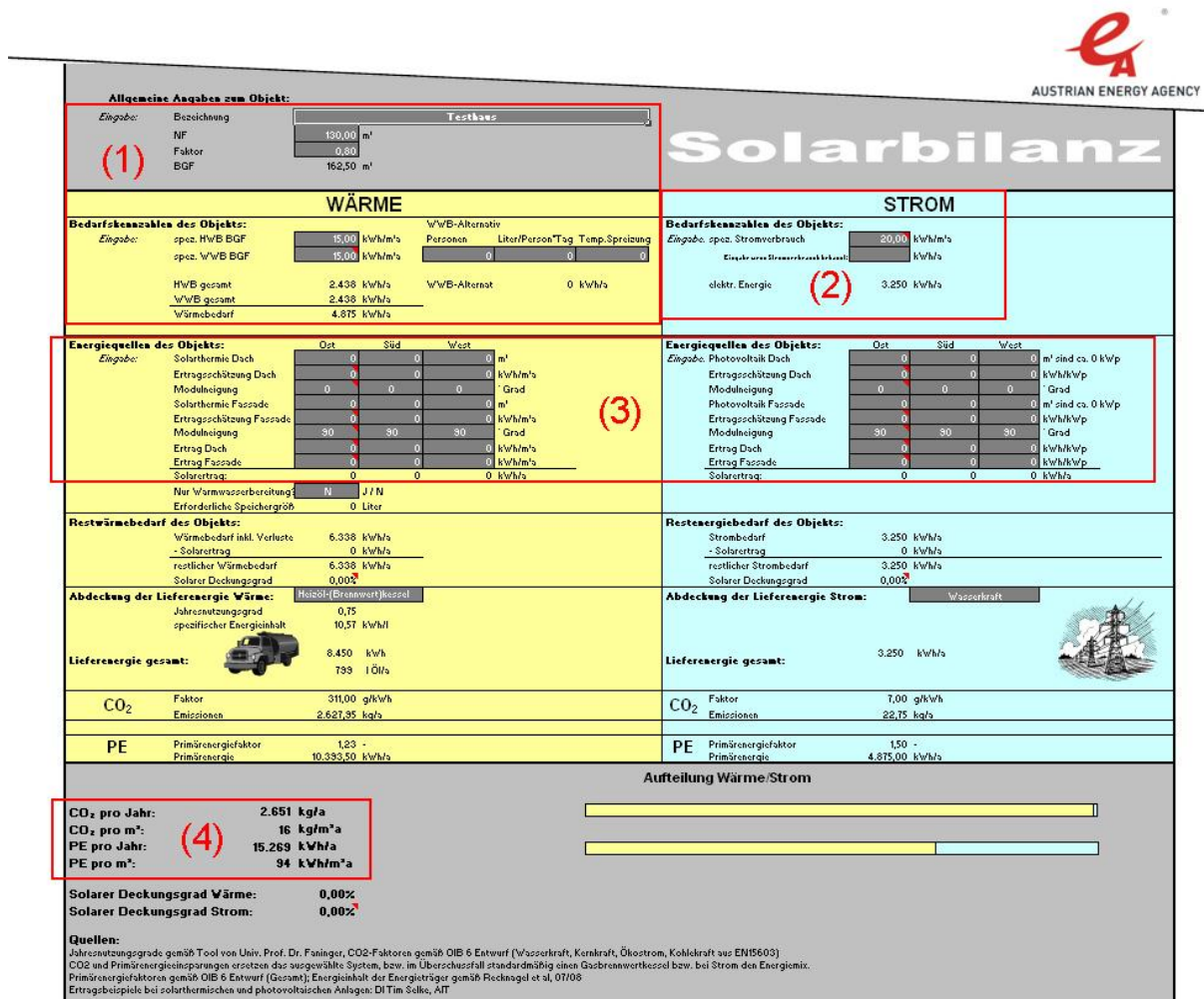

Figure 4: SolarBILANZ, a screenshot of energy balance: (1) heating and DHW calculation, (2) power requirements, (3) solar heat and PV potential and (4) CO₂ emissions

Energy balance module

Calculation of heating and hot water consumption

After the (expected) heating and hot water demand according to the energy performance certificate (or, alternatively, heating and hot water demand or hot water consumption estimations) and the living area of the building have been entered, the solar balance tool immediately calculates the heating and hot water demand of the building including the losses. A comment field facilitates the estimation of the hot water estimation (See Figure 4, marking 1).

Calculation of power requirements

After entering the current energy demand according to the energy performance certificate (or alternative current demand estimation), the solar balance tool calculates the current demand for the building. A comment field facilitates the estimation of the demand (Figure 4, marking 2).

Calculation of solar heat and photovoltaic potential

By entering the desired (or planned) solar thermal or photovoltaic areas, orientation and inclination of the system(s), and the reachable annual solar gains as indicated by the manufacturer, the solar balance tool will calculate the actual solar gains. The tool distinguishes between roof and façade usable area. In case there are no manufacturers' data, a comment field facilitates the estimation of the annual solar gains (Figure 4, marking 3).

Calculation of the CO₂ emissions and primary energy consumption

After selecting the kind of production and delivery of possibly the estimated remaining energy need, the solar balance tool calculates the CO₂ emissions and primary energy consumption of the selected systems for the specific building (Figure 4, marking 4).

Cost balance module

In addition, a cost module was implemented that allows the comparison of the investment and operating costs of renewable energy systems with the reachable financial profits.

Calculation of life cycle costs

The annual costs in the life cycle analysis of the system(s) are calculated in the cost-balance sheet of the tool. The investment costs as well as capital-tied, operational-tied and consumption-tied costs are taken into consideration in this analysis (Figure 5, marking 1).

Estimation of investment costs

If there are no investment costs available for the user, for example in a form of cost estimation, the SolarBILANZ tool automatically estimates them for the user (Figure 5, marking 2).

Calculation of external costs

The calculated CO₂ output together with the cost per ton of CO₂ emissions (e.g. emissions trading) leads to the calculation of the external costs. Again, a comment box supports the user (Figure 5, marking 3).

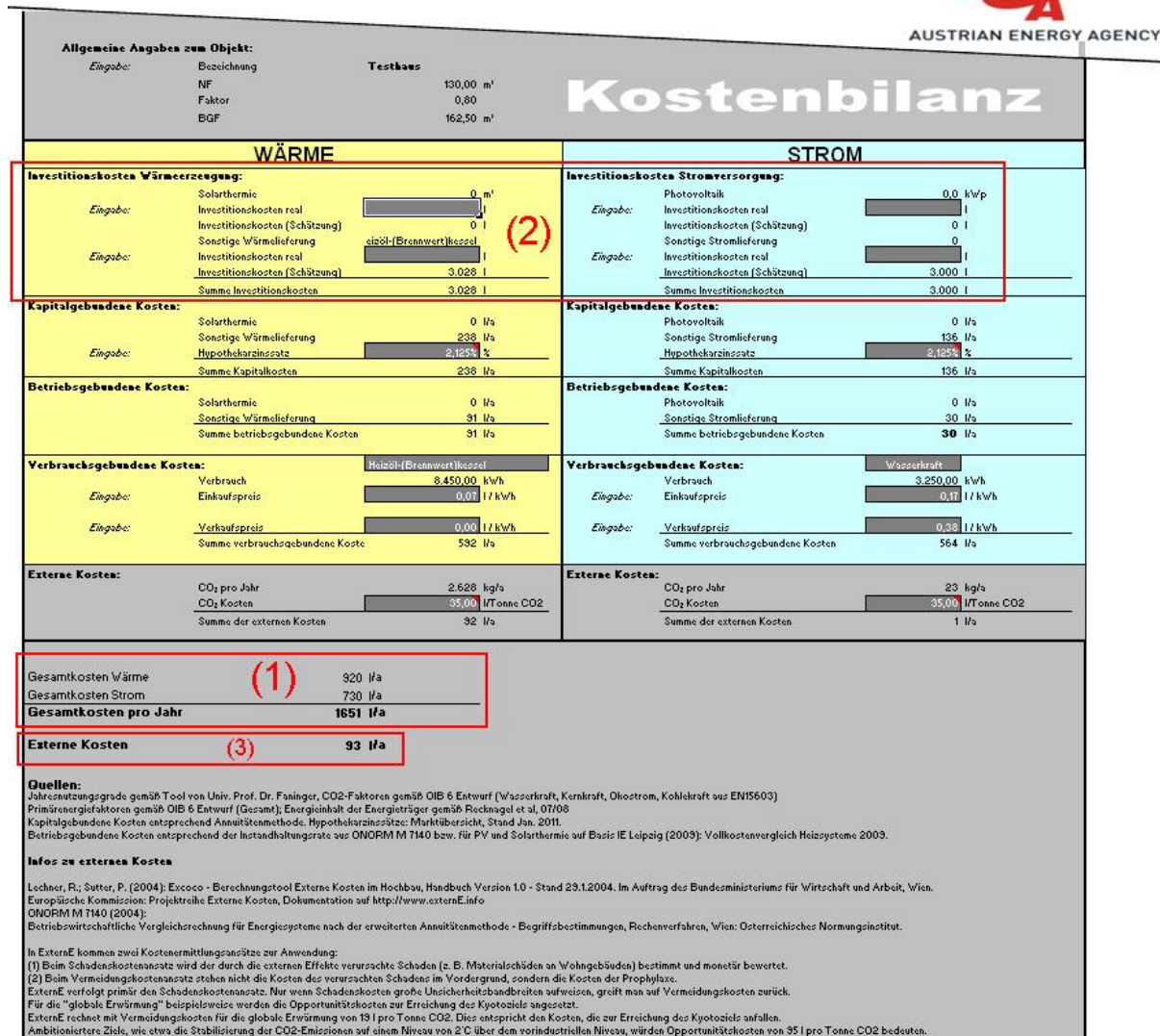

Figure 5: SolarBILANZ, a screenshot: a cost balance

2.2.12. bSol 4

bSol 4, standalone, consists of two products :

bSol ESQUISSE is meant to support architects in their work. At the stage of the draft design, the bSol Esquisse allows estimating the quality of the thermal comfort and the consumption of energy of a room or a whole building, within 5 minutes maximum. It allows discussing the influence of various constructive variants in real time.

bSol PRO allows to study the thermal behaviour of a room or a whole building by making an hourly calculation over a whole year. The embedded intelligence directly assigns users to the building elements with the biggest potential of energy optimization. It allows planners to quickly optimize the most relevant elements of the project. Wishing to offer a maximum of versatility, bSol PRO is also equipped with a SIA 380/1 engine (Swiss version only). The user needs to introduce the studied

building only once to cross from the hourly to the SIA 380/1 calculation mode. bSol PRO and bSol ESQUISSE are two different user interfaces using the same engine.

The output can be achieved in 4 steps if the required parameters are available.

bSol ESQUISSE

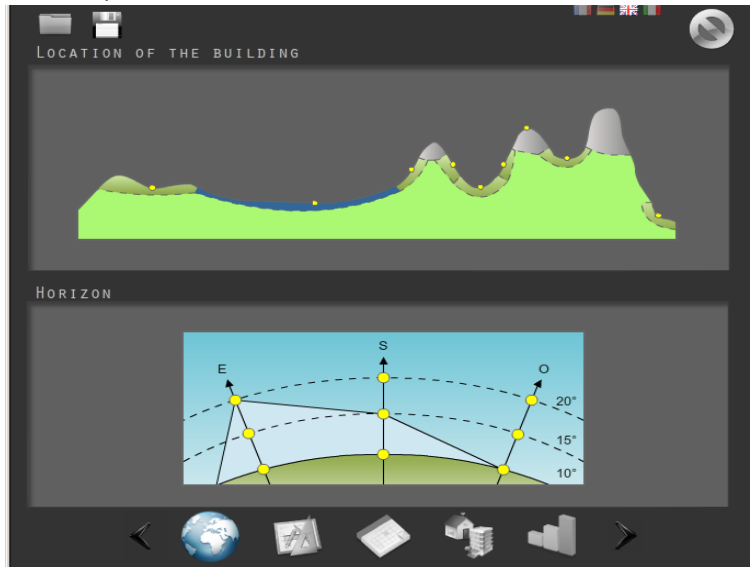

Input:

Step 1: Building location and horizon modelling

The user can select the climatic region where the project is located (today, only Swiss regions are supported).

The horizon is described graphically. For East, South and West, three different “heights” are available: 10 °, 15 ° and 20 ° which respectively represent 6 hours, 4 hours and 0 hours of sun of a mid-winter day.

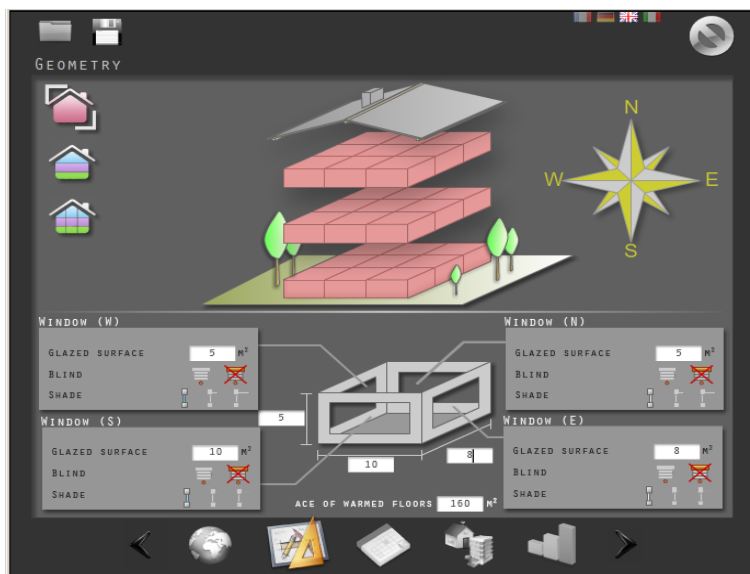

Step 2: Geometry modelling

Three different entry modes are possible:

- Complete building
- Floor by floor
- Room by room

Users can select the dimensions of the object, the windows for each façade and the specific sun blinds.

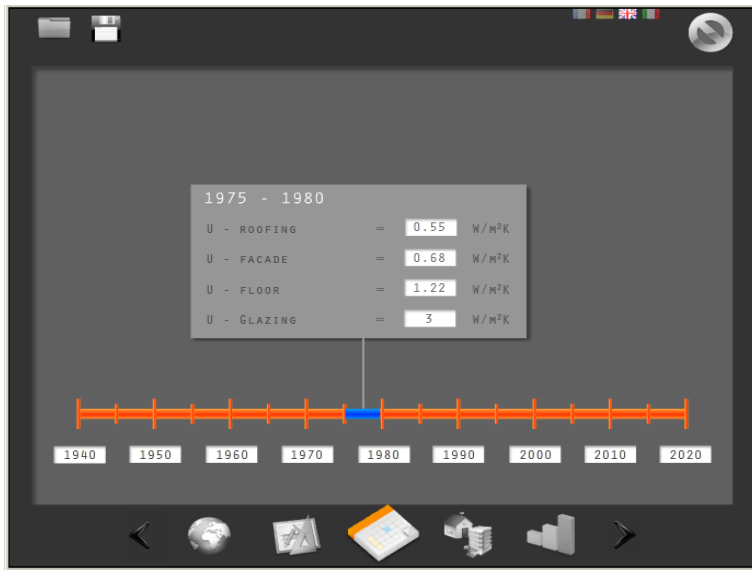

Step 3: Envelope quality

The quality of the thermal envelope can be selected according to a year of reference or by entering the U-values of each building element.



Step 4: Miscellaneous

In the last step, the user can choose parameters for the building operation, such as the building category, the presence / absence of ventilation heat recovery and the type of construction.

bSol ESQUISSE includes calculation profiles for single-family / multi-family houses and office buildings.



Outputs

Step 5: Results

1. Potential for reduced energy consumption.
2. Analysis of 10 parameters (U-Value of envelope, window area, calorific capacity, etc.) to determine the one with the biggest potential for improvement.
3. Net thermal power for room heating
4. Annual heating energy consumption
5. Evaluation of the overheating risk
6. Proposal on how to reduce the

overheating risk

- Annual sum of overheating hours (> 26°C)

bSol PRO

bSol PRO allows to study the thermal behaviour of a room or a whole building by making an hourly calculation over an entire year. The embedded intelligence directly assigns users to the building elements with the biggest potential of energy optimization.

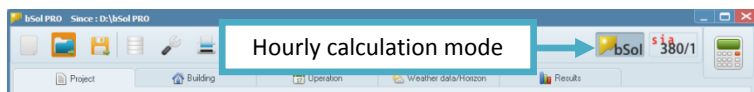

bSol PRO is SIA 380/1 certified. It allows making either a SIA 380/1 calculation or an hourly calculation using the same building description.

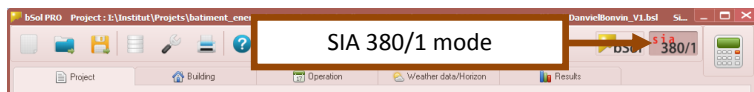

bSol PRO allows importing a bSol Esquisse project.

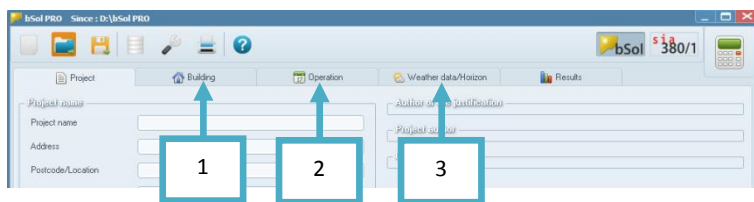

Inputs

- Building geometry
- Building operation parameters
- Building location (selection of weather data and horizon).

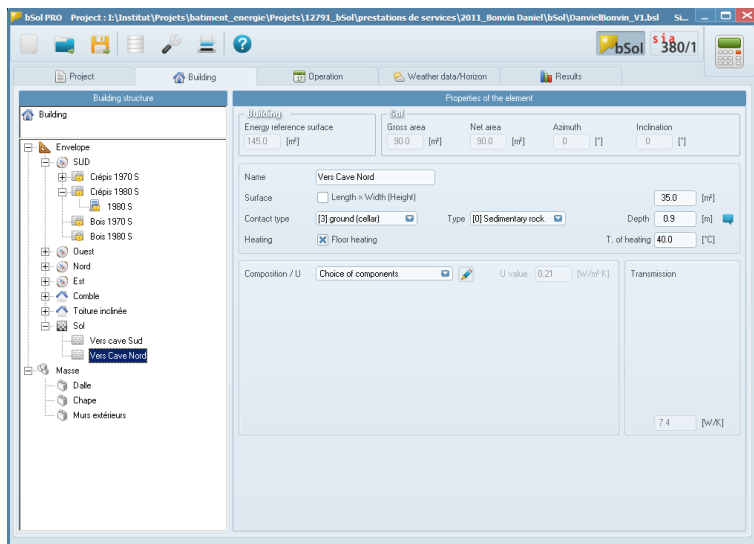

Step 1: Description of the building

The left side of the entry window presents a tree diagram of the building with the following structure:

- Azimuth / orientation
 - Wall / roof / ground
 - Windows
 - Wall 2 / roof 2 / ground 2
- Azimuth 2 / orientation 2
- Etc.

The right side of the entry window shows all the information related to the selected elements (dimensions, U-value, contact type, ...)

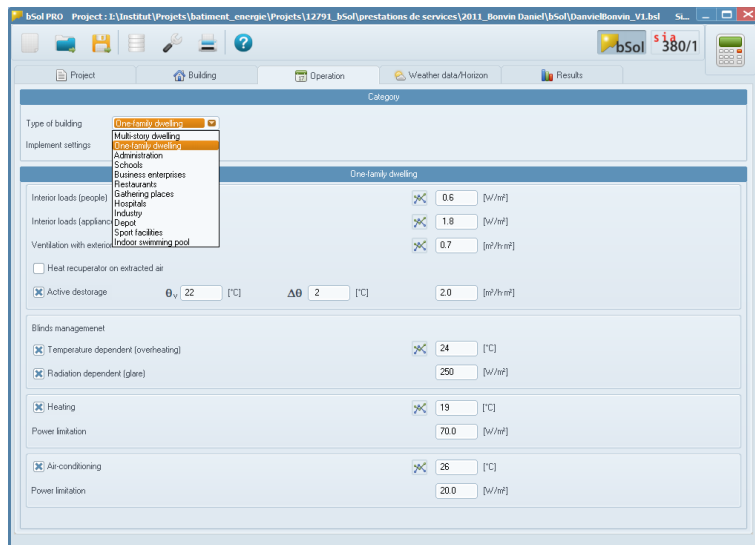

Step 2: Parameters of operation

Definition of the parameters of operation, reflecting the type of use and behaviour of occupants, such as temperature settings, ventilation system or control of sun blinds.

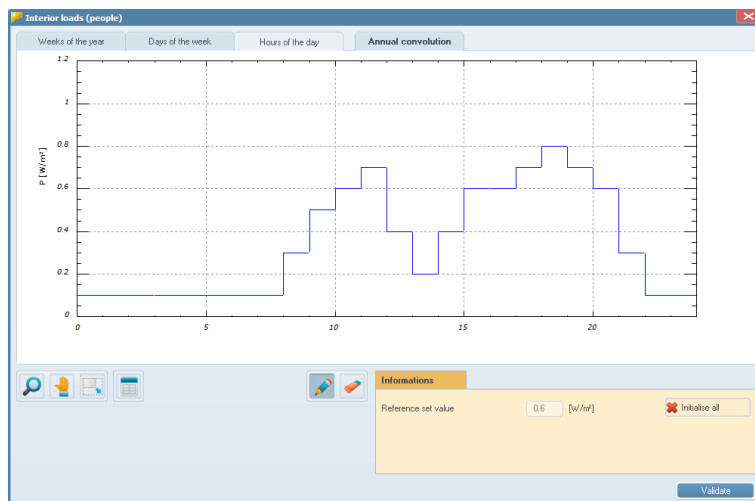

The settings for the following occupancy related parameters can be defined on an hourly, daily or weekly basis to better simulate the behaviour of the occupants:

1. Internal gains (people and appliances)
2. Natural ventilation
3. Control of sun blinds
4. Interior temperature settings (heating / air-conditioning)

There are three different input modes available:

1. Direct editing using the corresponding chart
2. Manual entry of the desired values in the "Specific instructions" window
3. Import of data from a spreadsheet

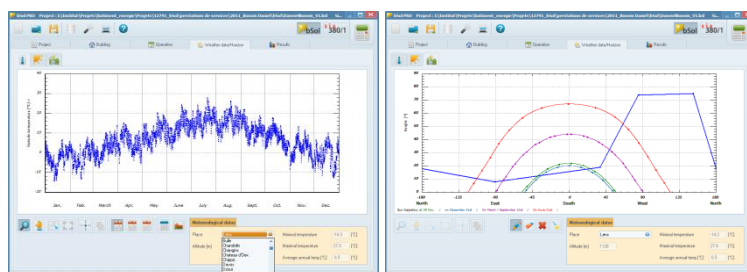

Step 3: Climate data and horizon description

By default, bSol is delivered with 25 weather data sets. It is possible to create a personalized meteorological file, either by importing the file directly from Meteonorm or by creating it according to a specific model.

The horizon points can directly be defined in bSol or be imported as a data file.

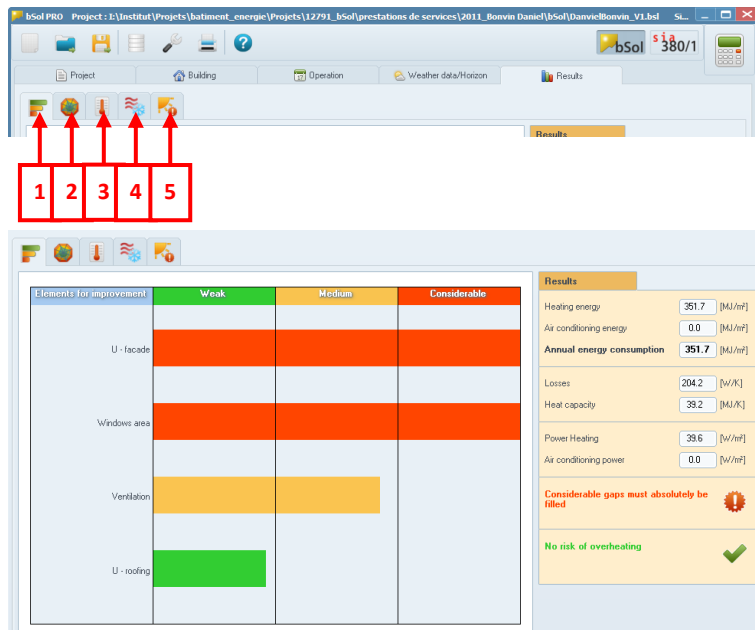

Output

Step 4: Results - hourly calculation

The result window is divided in five sections:

1. Potential for improvement (bar chart):

Parallel to the main simulation, bSol performs a sensitivity study on 12 main parameters and displays the 4 elements with the greatest potential for improvements.

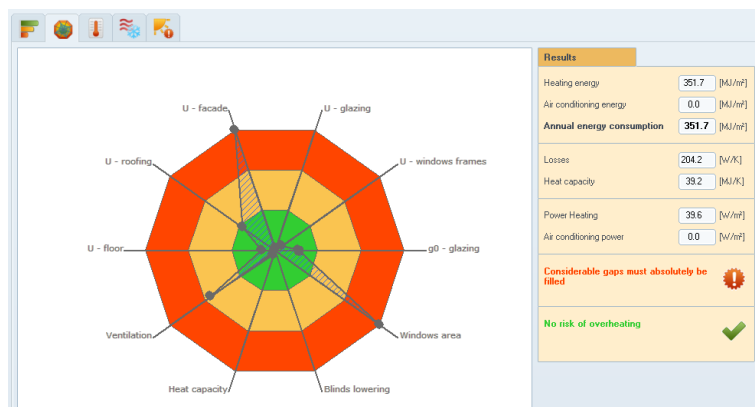

2. Potential for improvement (spider web chart):

This chart takes the above information concerning potential for improvement and displays it in a different form. The colour code is the same as in the previous one; red represents the greatest potential for improvement.

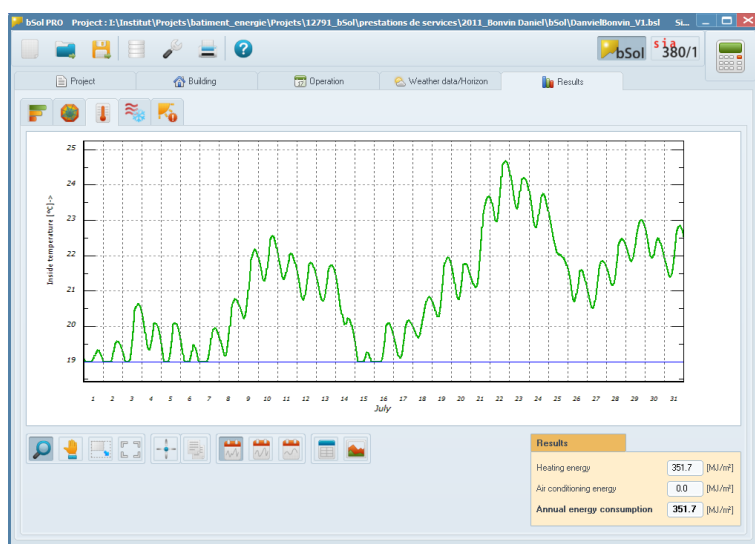

3. Interior temperature (graph):

This graph displays the hourly interior temperature over a simulation year.

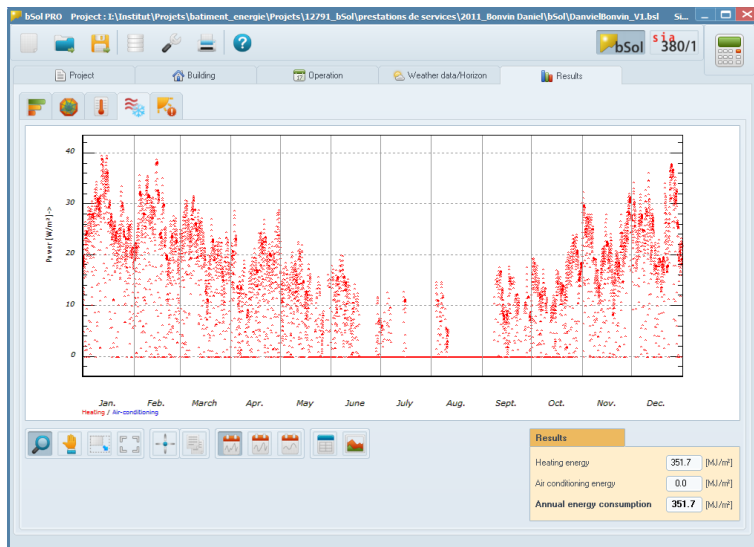

4. Heating / air-conditioning demands (diagram):

This diagram displays the specific level of heating / air-conditioning demands required to maintain the desired climate within the building on an hourly basis.

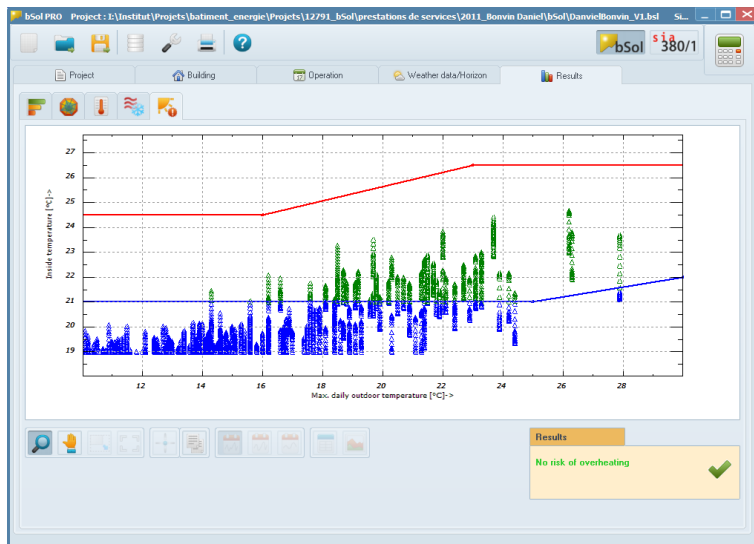

5. Overheating (graph):

The SIA 382/1 standard defines overheating according to the maximum daily outdoor temperature. bSol Pro calculates the annual number of hours in which the interior temperature exceeds the defined limit.

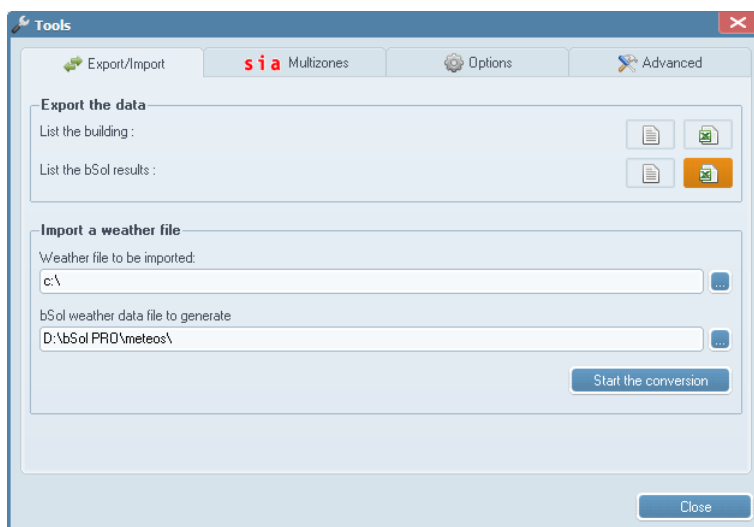

Step 5: Export of the results

bSol allows to export the results directly into a spread-sheet, e.g. Excel.

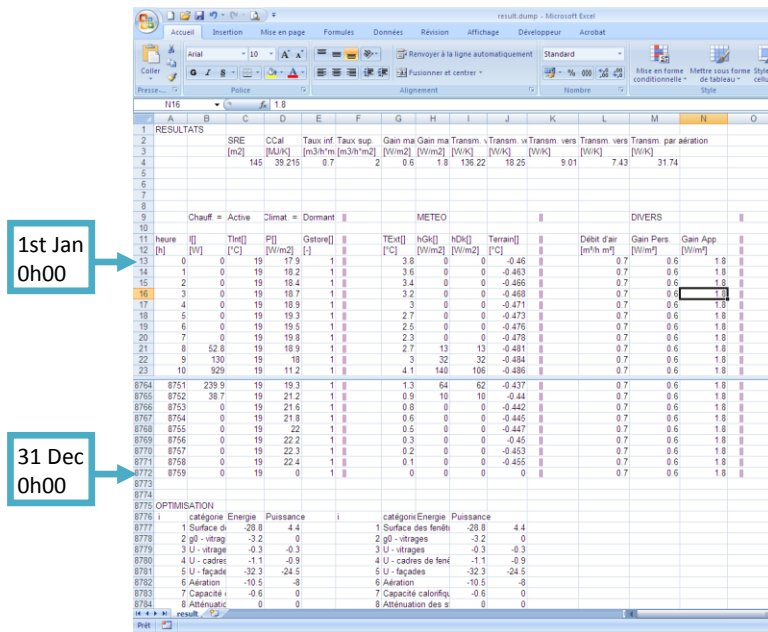

bSol results in Excel

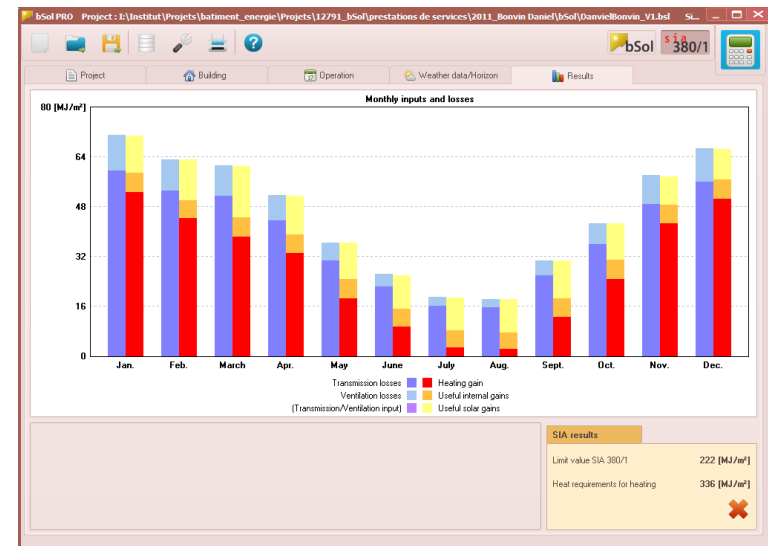

Output SIA 380/1

The “Results” bar chart displays the various monthly and annual thermal losses and gains as well as the annual heating requirements. They are opposed to the limits given by SIA 380/1 standard for the respective building type.

Step 6: Reporting

With bSol PRO it is possible to automatically generate three different reports:

- Certified SIA 380/1 report
- bSol summary report (1 page)
- bSol full report (building description, settings of operation parameters, U-value of building envelope).

2.2.13. DAYSIM

Daysim is a dynamic and climate-based daylight modelling package for the design and analysis of daylighting, shading devices and lighting control models and lighting energy use (Reinhart, 2006; Reinhart, 2010). An annual illuminance profile can be easily achieved by employing Radiance basic

algorithms and daylight coefficient (Reinhart and Walkenhorst, 2001; Reinhart, 2001). Compared with Radiance, Daysim calculations can be carried out by inputting weather data of the site (using Perez sky model (Perez et.al., 1993)) and building models. As a free tool running in Windows and Linux OS, it provides complete freedom to simulate complicated environments with a higher accuracy.

Calculated values included the annual illuminance profile, daylight coefficient, daylight factor (DF), daylight Autonomy (DA), Continuous Daylight Autonomy (DAcon and DAMax) and Useful Daylight Index (UDI) (UDI<100, UDI100-2000, UDI>2000) (Reinhart, 2006). In addition, Daysim is a tool used for dynamic visual comfort analysis in daylit spaces (Daylight Glare Probability) (Reinhart, 2010). Models made in Ecotect or Google SketchUp can be converted into Daysim files. Daysim results can also be exported to other packages for further analysis (Reinhart, 2006).



Ecotect view 1

Step 1- the views of indoor spaces

The model is built in Ecotect.

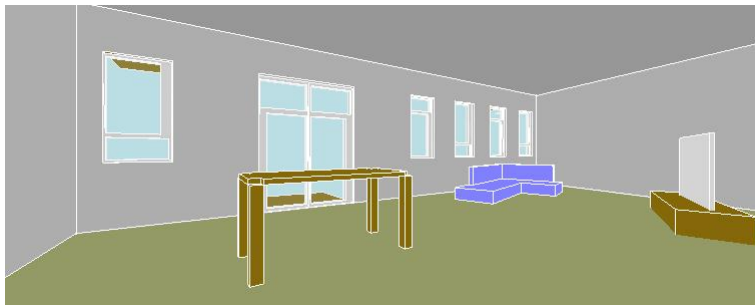

Ecotect view 2

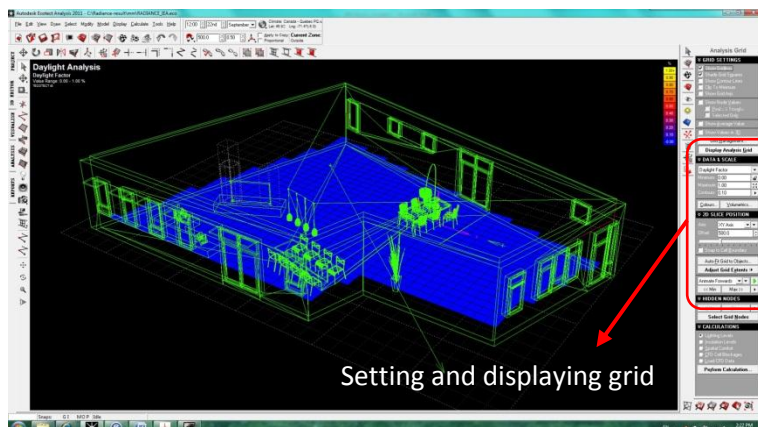

Step 2- setting analysis grid

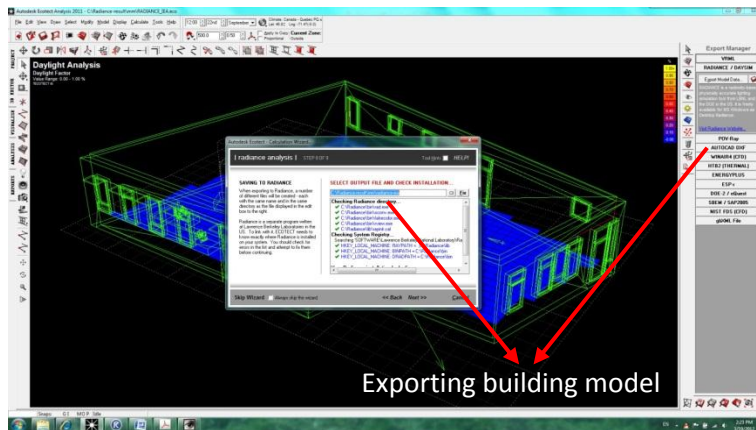

Step 3- exporting files for Daysim simulations

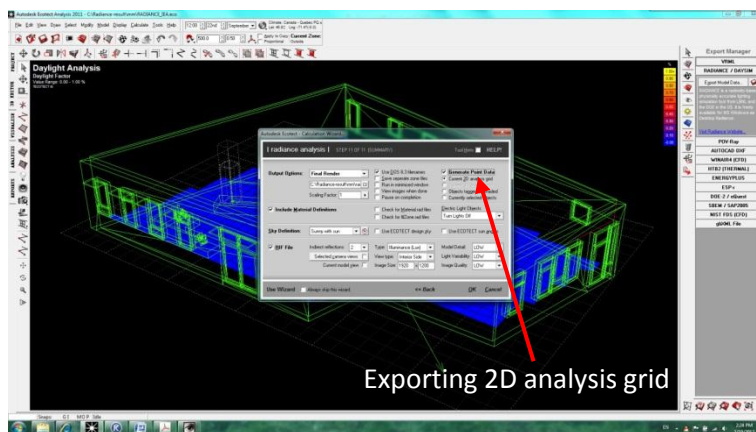

Step 4- preparations for Daysim simulation

Welcome to DAYSIM

In case you want to import your Daysim projects from Ecotect, you should initially work through the 'GETTING STARTED WITH ECOTECT/RADIANCE/DAYSIM' document which is available from HELP>>GETTING STARTED. Otherwise, you should start with example 5.1 in the Daysim Tutorial (HELP>>DAYSIM TUTORIAL). You are also strongly encouraged to work through chapters 1 and 2 in the tutorial.

Starting Daysim project

Quick Start

- In a nutshell, to set up a Daysim project, you have to:
- Step 1 - Create a new Daysim project under FILE>>NEW PROJECT
- Step 2 - Load an annual climate file under SITE
- Step 3 - Import a building model and a sensor point file under BUILDING
- Step 4 - Calculate a set of daylight coefficients as well as an annual illuminance profile under SIMULATION
- Step 5 - Analyze your results under ANALYSIS

Happy Simulations!

Loading weather data for a particular location

Step 1 - Daysim project successfully created

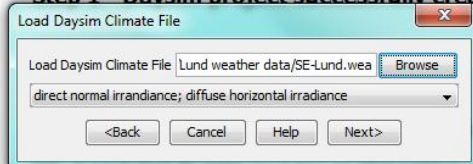

FILE menu.

illuminances in a fixed time step, e.g. one hour, five minutes or even one minute. Climate files are used by Daysim to calculate annual illuminance or luminance profiles for each sensor specified under the BUILDING menu. You have the choice to:

- (1) Download and import Energy Plus climate files from the Internet,
- (2) Load in any Daysim climate file that you have previously generated. (Daysim climate files are usually stored on your hard drive.)

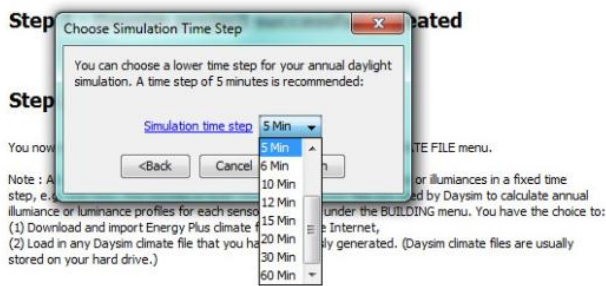

Converting original weather data according to required time step



Site information and ground reflectance setting

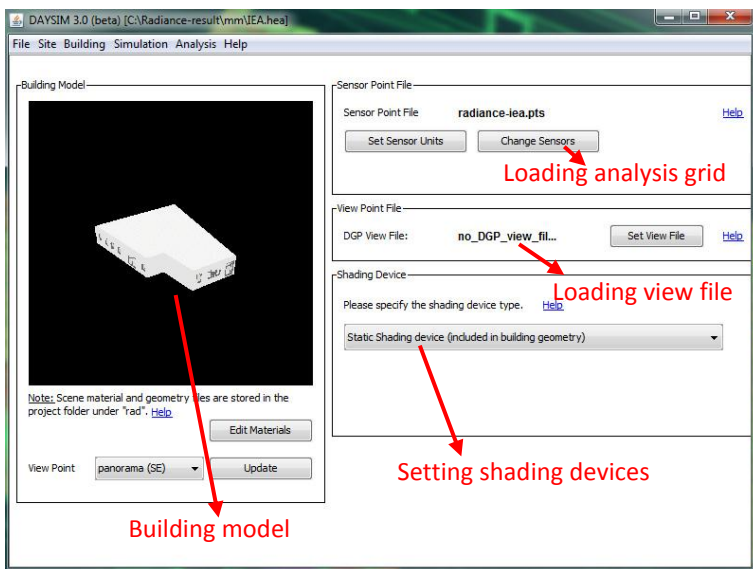

Step 5- model description

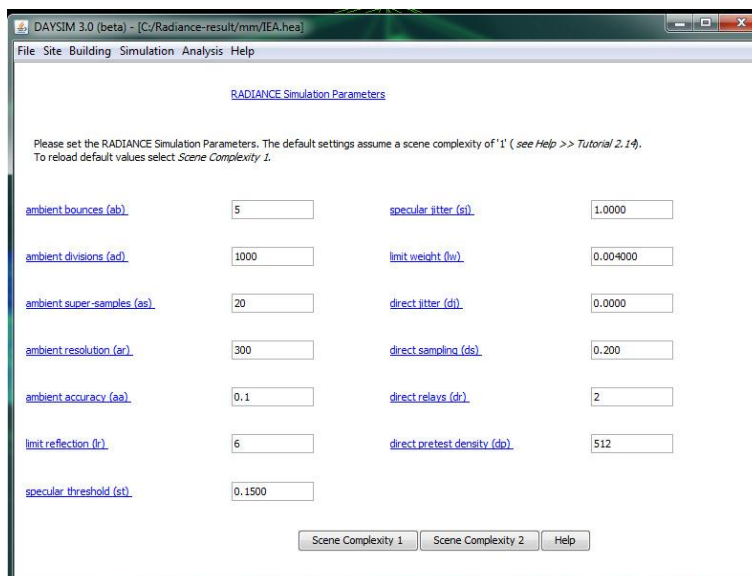

Step 6 – setting simulation ambient parameters

The explanations of typical ambient parameters (directly taken from Reinhart, 2006):

ambient bounces: This parameter describes the number of diffuse interreflections which will be calculated before a ray path is discarded. An ab-value of 5 is already sufficient for a standard room without any complicated façade elements.

ambient division: The ad-parameter determines the number of sample rays that are sent out from a surface point during an ambient calculation. This parameter needs to be high if the luminance distribution in a scene with a high brightness variation. An ambient sampling parameter greater than zero determines the number of extra rays, that are sent in sample areas with a high brightness gradient.

ambient accuracy and ambient resolution : The combination of these two parameters with the maximum scene dimension provides a measure of how fine the luminance distribution in a scene is calculated. According to page 385 in *Rendering with Radiance*, the combination of $aa=0.1$, $ar=300$ and a maximum scene dimension of 100m yields a minimum spatial resolution for cached irradiances of:

ambient resolution = maximum scene dimension x ambient accuracy

direct threshold: This option switches off the selective source testing, i.e. each light source is equally considered during each shadow testing. This option is automatically set to zero when direct daylight coefficients are calculated using DAYSIM.

direct sub sampling: This option switches off the direct sub sampling threshold, i.e. only one ray is always sent into the centre of each light source. As during the calculation of the direct daylight coefficients only solar discs with an angular size of 0.5 are present, disabling direct sub sampling speeds up the calculation without impeding its accuracy.'

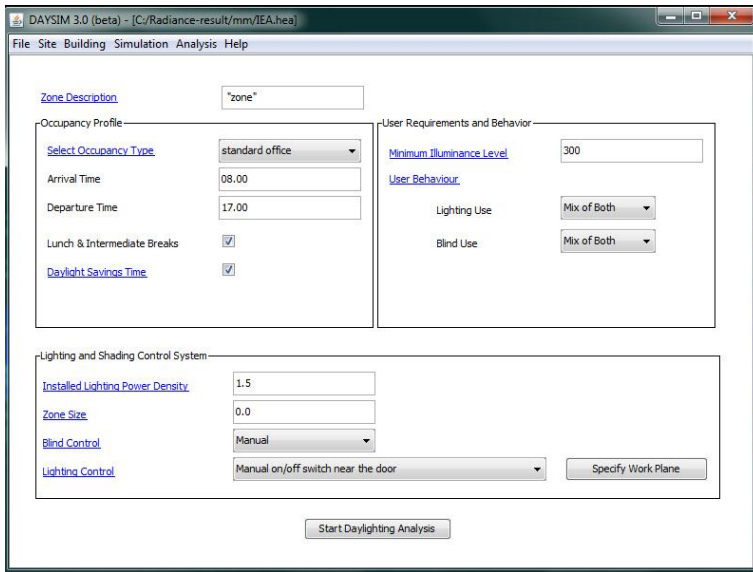

Step 7 – simulation and results analysis

The simulation can be triggered after setting proper ambient parameters.

The simulated results can be further analysed with occupancy and control model settings.

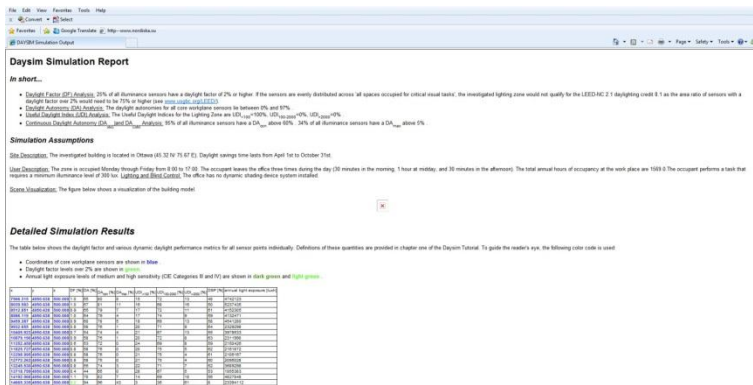

Step 8 – results displaying (html version)

Simulations results displayed as numerical values

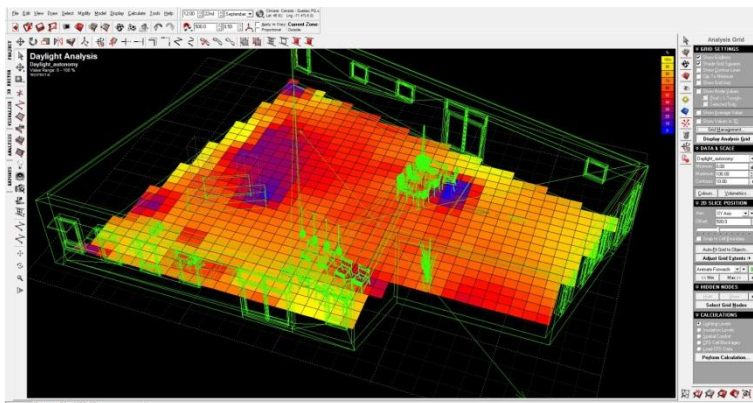

Step 9 – results displaying (in Ecotect)

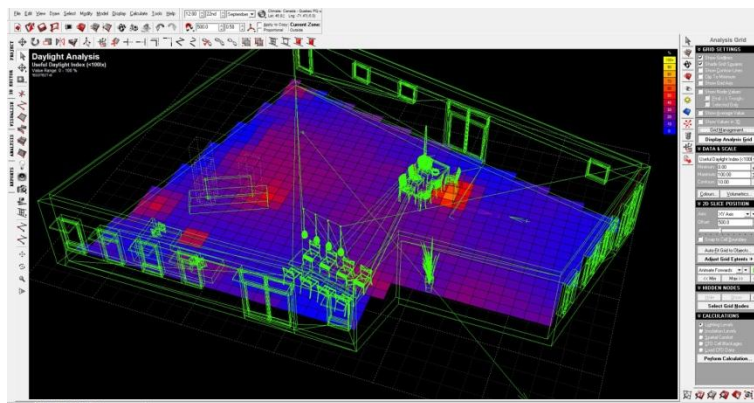
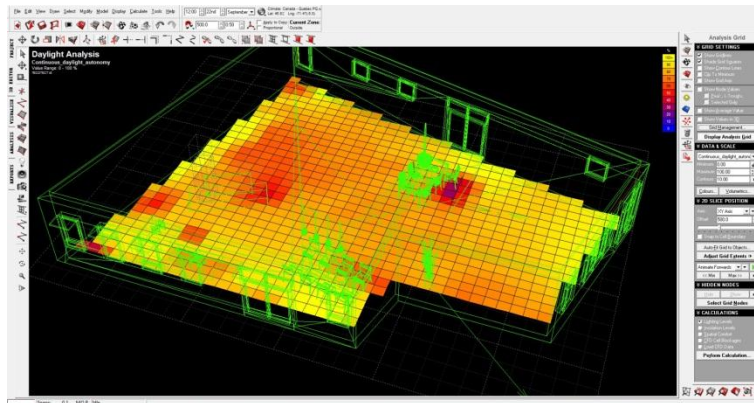

Limitations

Daysim has no model editor functions. Any physical building models need to be produced in other packages (SketchUp, AutoCAD etc) and converted into Radiance files before imported into Daysim.

2.2.14. Design Performance Viewer (DPV)

Version: 380 - 1.3.933

Calculation Models

DPV 380, which is available for download, uses the following performance calculation models:
Heating Energy Demand: SIA 380.1 (Swiss Norm) for Swiss locations.

Features

- Automatic assessment of model geometry and building element properties
- Steady-state calculation model of SIA 380.1
- Climate files for 24 locations in Switzerland
- Calculation of CO₂ emissions on the basis of exergy
- State and process visualization
- Building model including all building related data
- Possibility to exchange the building model without losing information

Requirements

DPV is a plug-in for the BIM modelling software Autodesk Revit Architecture. Right now, DPV can only be used in relation to Autodesk Revit Architecture.

The output can be achieved in two steps if the “.ifc”-model is correctly specified.

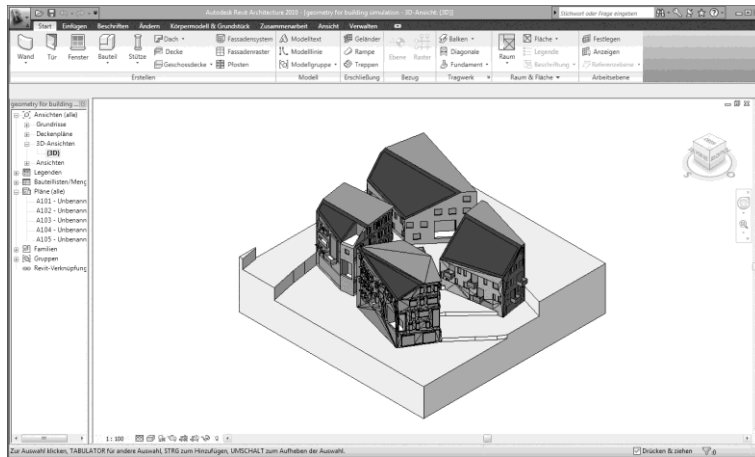

Step 1: Import

Open the “.ifc” building model in Autodesk Revit

Step 2: Building Model Control

For its calculations, DPV requires correctly defined components. A roof needs to be created as an “.ifc” roof element and a wall as an “.ifc” wall element and an intermediate floor with an “.ifc” basement ceiling element, etc. These components must be placed at the correct levels, and their height parameters must be correctly linked. The total floor space must be tagged with space objects / space stamps.

Step 3: Parameters for Calculation

DPV calculates the annual heating energy demand for the Swiss standard SIA 380 / 1 (2009), using EN ISO 13790 as basis. The calculation method is applicable to new and existing buildings. The heating demand and its components (losses / gains) refer to the floor area defined by SIA 416 / 1 and are shown in MJ/m².

For calculation, the following parameters are required:

- Type of use;
- Data for room temperature control;
- Data of the respective climate station;
- Energy reference area;
- Data of the surface components (areas, U-values, room temperature of adjacent heated space, temperature and radiator specifications, thermal bridges, etc.);
- Reduction factors for unheated spaces and spaces against the ground;
- Product data for windows (g-value, shading flat factors, etc.);
- Heat storage capacity.

DPV Project Properties

Location: Zürich SMA (SZ/ZH)

Building type: Single

Construction type: Medium

Global heat bridges: Average

Temperature Control: Single

Horizon: N: Small (10°)

Horizon: NE: Small (10°)

Horizon: E: Small (10°)

Horizon: SE: Small (10°)

Horizon: S: Small (10°)

Horizon: SW: Small (10°)

Horizon: W: Small (10°)

Horizon: NW: Small (10°)

Areas

Heated Floor Area: 2976 m²

Exterior Wall Area: 2760 m²

Window Area: 781 m²

Roof Area: 292 m²

Floor To Ground Area: 291 m²

System Properties

Heated surface area ratio: 70 %

Energy source temp: 0 °C

Inlet temperature heating: 40 °C

Close Save

Most of this information is already defined through the *ifc building model. A few additional parameters must be specified on the DPV interface:

1) Site and building

- Location
- Building type
- Construction type
- Global thermal bridges
- Type of temperature control

2) Orientation

- Horizon N, NE
- Horizon E, SE
- Horizon S, SW
- Horizon W, NW

3) Areas

- Heated floor area
- Exterior wall area
- Window area
- Roof area
- Floor to ground area

4) System properties

- Heated surface area ratio
- Energy source temperature
- Inlet temperature heating

Step 4: Calculations with DPV

A) Energy Balance

On the flow diagram of the interface, the energy flows of the current draft class are displayed. The arrows on the right show the energy losses through the building envelope. The energy that is required to compensate the losses is shown by the arrows on the left. The thickness of the arrows represents the respective energy gains and losses in relation to the total energy demand (white arrow in the middle = 100%). Beneath the graph, the respective numeric values are given.

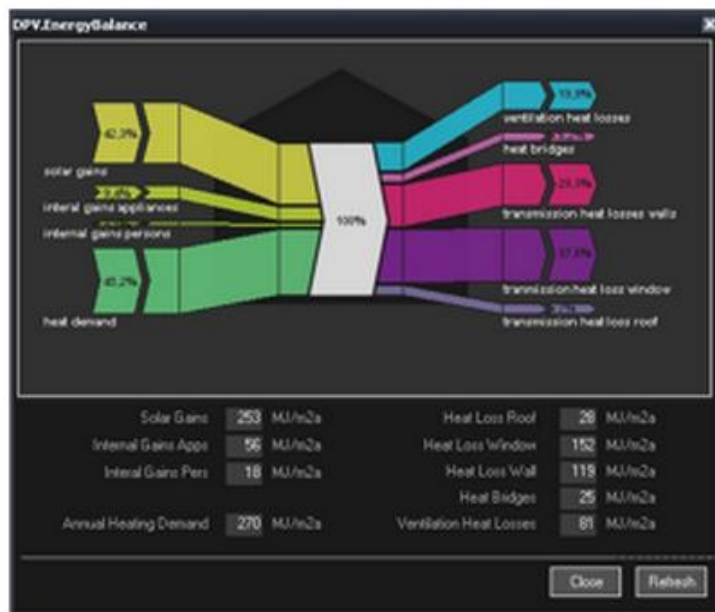

Parameters of the energy balance

- Solar gains
- Internal gains: Appliances
- Internal gains: persons
- Annual heating demand
- Heat loss: Roof
- Heat loss: Window
- Heat loss: Wall
- Thermal bridges
- Ventilation heat loss

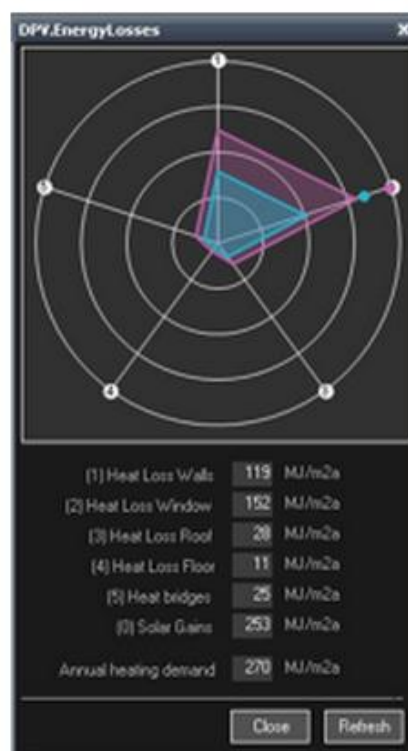

B) Energy Losses

The spider diagram shows the specific transmission heat losses covered by the individual components. The current state of the design is shown in the blue area and the previous state in the pink one. Values near the centre mean less losses. Amendments in the design have a direct impact on shape and location of the respective areas. Beneath the spider diagram, the numeric values are given.

Parameters of energy losses

- (1) Heat loss: Walls
- (2) Heat Loss: Windows
- (3) Heat loss: Roof
- (4) Heat loss: Floor
- (5) Thermal bridges
- (6) Solar gains

Annual heating demand

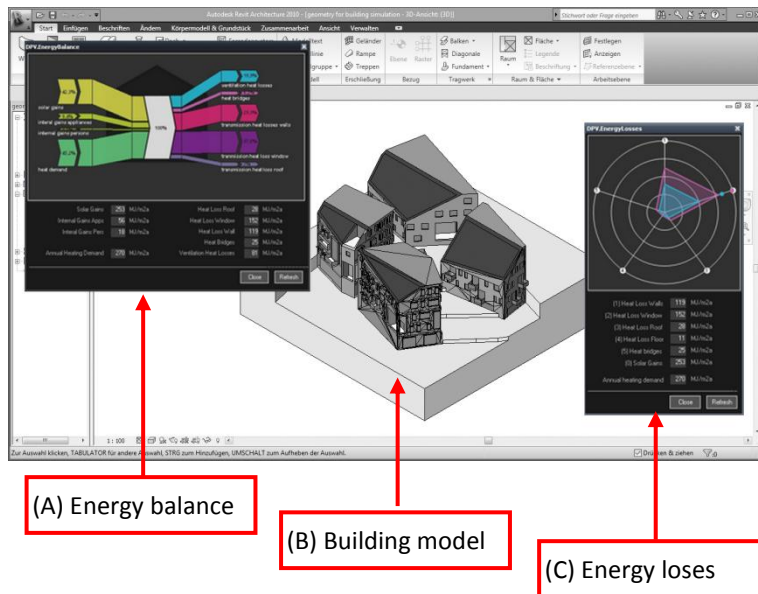

Calculation Output

DPV allows free arrangements of the results (A+B) and the building model (C) within the window, giving a meaningful representation of the building performance. However, these output arrangements cannot be exported; a print screen is necessary.

2.2.15. Lesosai

Lesosai version 7.1 was launched in March 2011. It is a tool for certification and thermal balance calculation of buildings, containing one or more heated or cooled zones. Regarding solar energy, it allows to estimate passive solar gains and pre-dimensioning Solar Thermal and Photovoltaic systems. This can be achieved through the “Polysun Inside” module, for more accurate hourly calculation, SIA380/4 & hourly calculations and RT2005 France, for simplified PV systems calculations.

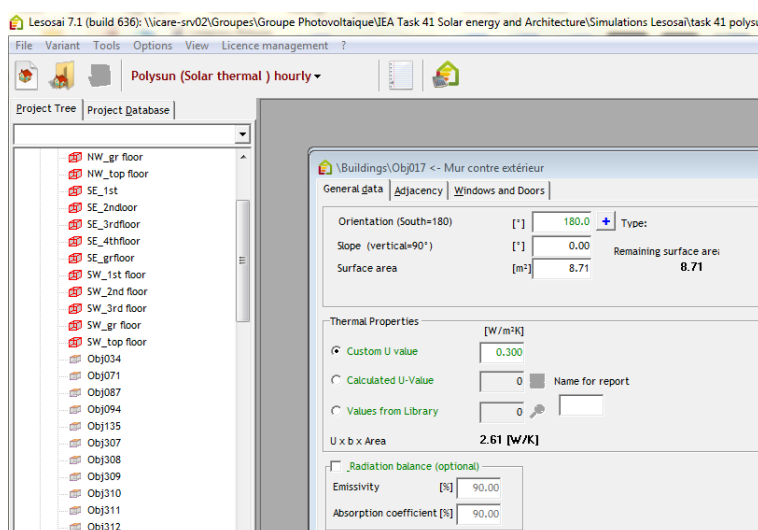

Data input

There are three different approaches for building definition within the software:

1. “Traditional” method (image on the left), with dimensions and values of the building envelope and technical data input, for more advanced design phases.

This new version of the software includes a 3D visual feedback of the building. It is possible to rotate the image around the north axis, and visualize selected elements of the envelope.

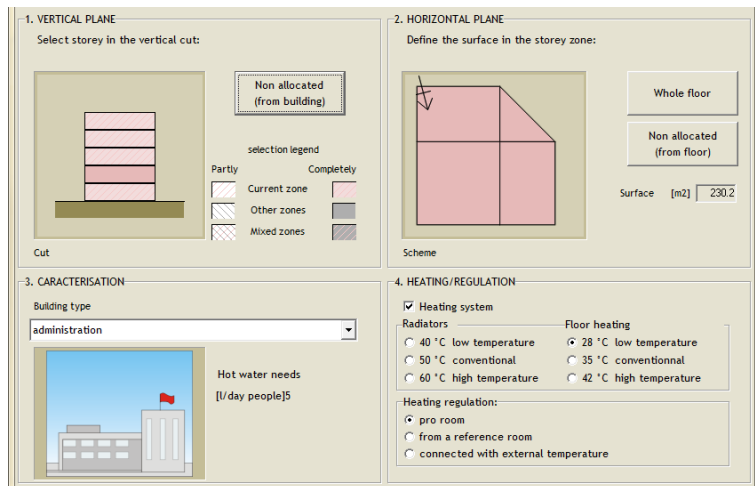

2. “Wizard” method, ideal for early design phases or retrofits.

The user can choose among seven pre-defined geometries. Most of them have the option of pitched roof.

In particular cases, after completing the wizard phase, the user can adjust envelope elements i.e. the roof’s slope in the traditional version of the software.

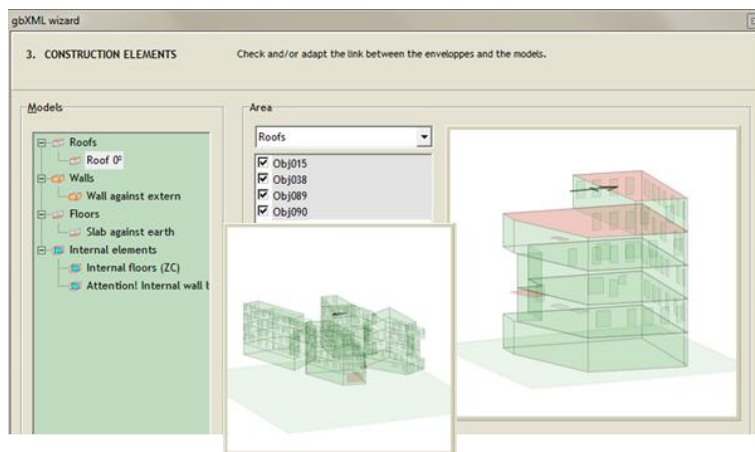

3. Importing gbXML files, with the aid of a wizard for further detailing.

A number of thermal zones can be defined, with different uses for each one. It is possible to define the envelope and some internal element’s materials, as well as windows and openings.

With this new feature, it is possible to import a gbxml file with more than one building. For the moment, the software recognizes the whole lot with group of buildings as one single entity. In this case, the user can create different thermal zones for each building. However, it is only possible to set one solar system (PV and ST) for the whole lot. Thus, it is better to separate gbxml files, at least for this 7.1 version.

gbxml import wizard screenshot, with one, and four buildings

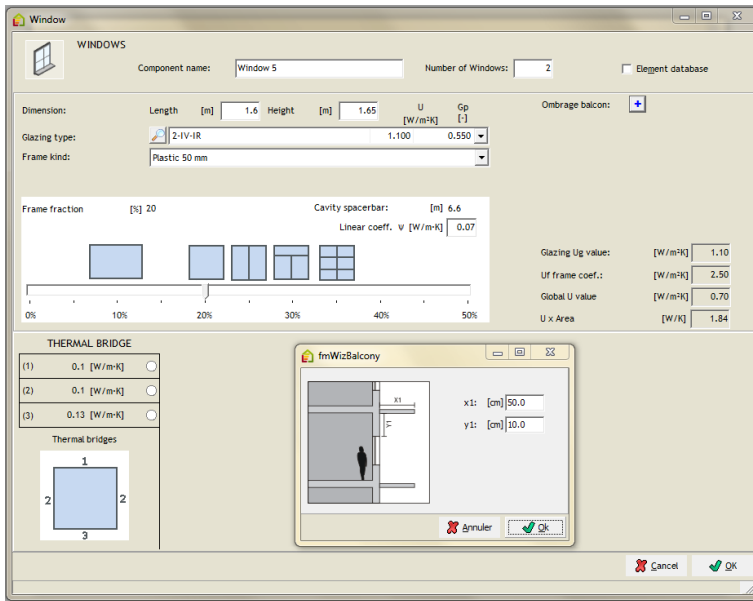

Passive and active solar input

Definition of windows, with basic balcony shading in the wizard version. More accurate details, as particular framings, shading coefficients, lateral screens and near horizon can be defined afterwards, with Lesosai traditional part.

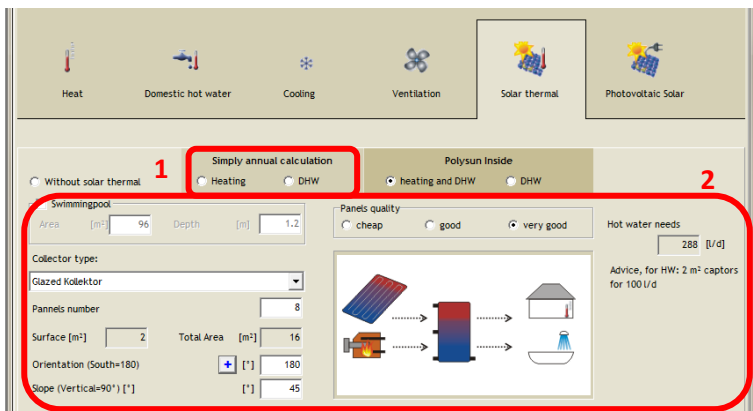

Technical systems: it is possible to quickly pre-define a building's solar thermal and photovoltaic systems, also in the early design phase.

Solar Thermal: The user can choose between the simplified method (1) of calculation - it gives an order of magnitude of the system - and the "Polysun Inside" (2) hourly calculation

If the wizard is being used and the assessment is for space heating and DHW, it is necessary to select the heating system and the storage on the traditional version of the software. If the analysis is only for DHW, the Polysun calculation can be accomplished right after the wizard steps are concluded.

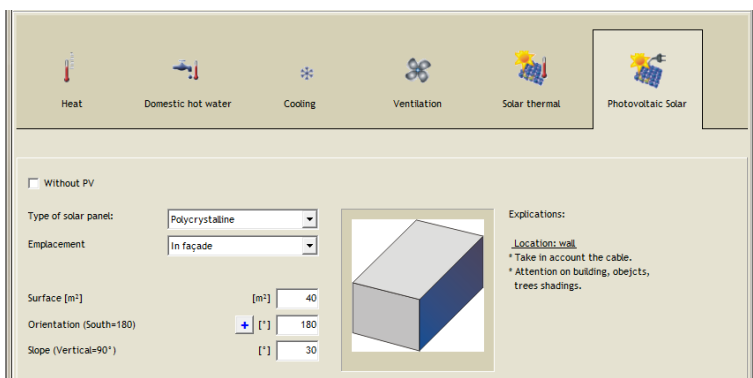

Photovoltaic: It is possible to add a photovoltaic system to a building according to SIA 2031, CEN hourly and RT2005 methods. "Polysun Inside" module still does not include this feature. Once again, it gives only an order of magnitude, and does not replace accurate methods.

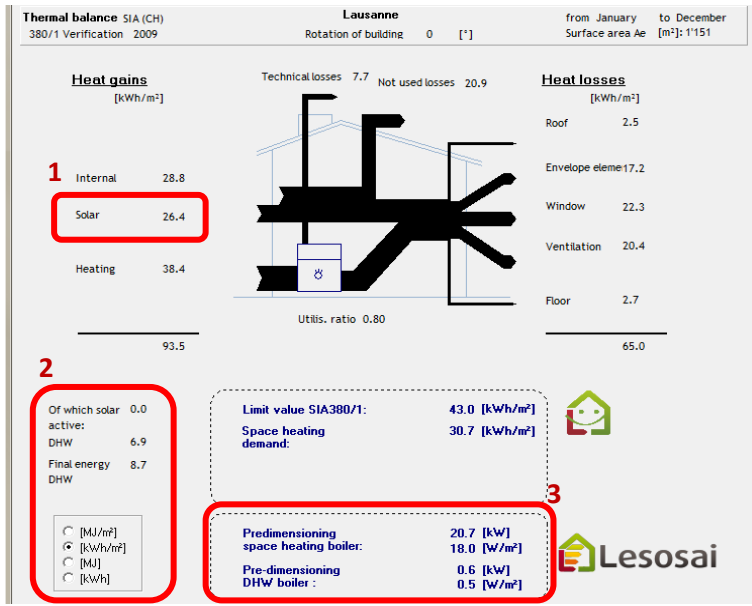

Thermal balance with SIA 380/1

1. Passive solar gains.
2. Domestic hot water energy consumption.
3. Boiler for domestic hot water and space heating pre-dimensioning.

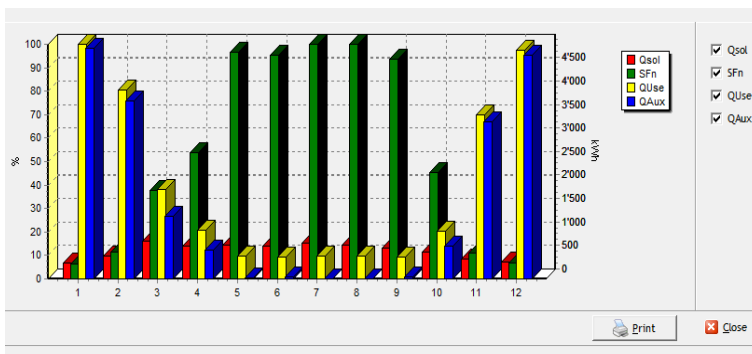

Polysun Inside

It is possible to directly print an output report, with information of DHW yearly and daily needs, type, quantity, slope, total area and orientation of solar thermal collectors and its tank. Furthermore, the graphic shows: **Solar fraction** (SF_n, fraction of solar energy to system), **Solar thermal energy** to the system (Q_{sol}), **Total energy consumption** (Q_{use}), and **Heat generator energy** to the system (Q_{aux}, solar thermal energy is not included).

Although these values are useful for experts, architects might have some difficulties in interpreting them. The storage capacity of the tanks are still limited to small systems, but will soon be updated.

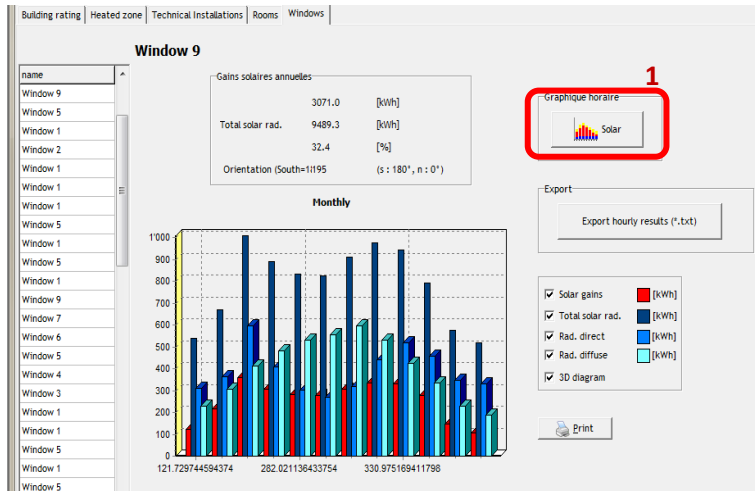

With **SIA hourly calculation method**, monthly solar gains as well as direct and diffuse irradiation values are available. If desired, the user can also analyse hourly results (1), i.e. shading and natural light for each window.

2.2.16. Polysun

Version: 5 (2011) includes the following calculation modules:

- Solar thermal
- Photovoltaic
- Heat pump
- Combination of all options, including cooling

Polysun is designed for installers, energy consultants and suppliers. The software enables project data to be managed in a clear and effective manner, allowing the comprehensive documentation of single client systems. No detailed input is needed to calculate a system. It is not (yet) possible to import digital building models. The numeric data has to be entered manually.

The calculation module for photovoltaic is shown in the following example. The output can be achieved in 9 steps.

Step 1: Building Data input

Size of the respective PV area
(calculated / manually entered)

Project Villa Village

$$\text{Roof}_{\text{area}} = \text{PV}_{\text{area}} = 430 \text{ m}^2$$

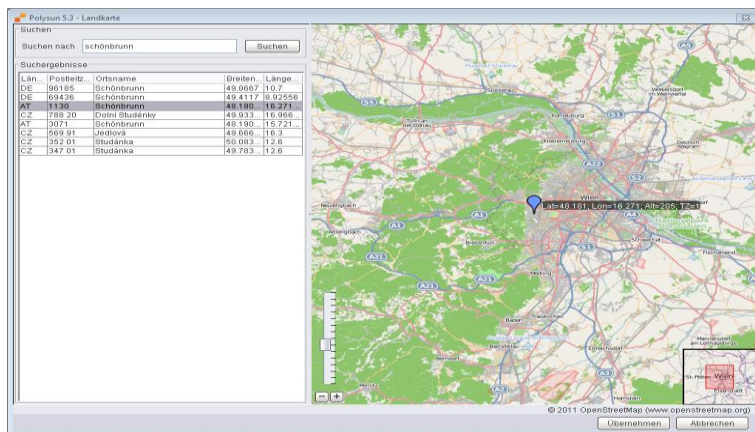

Step 2: Project location selection

Project location selection from map or coordinates

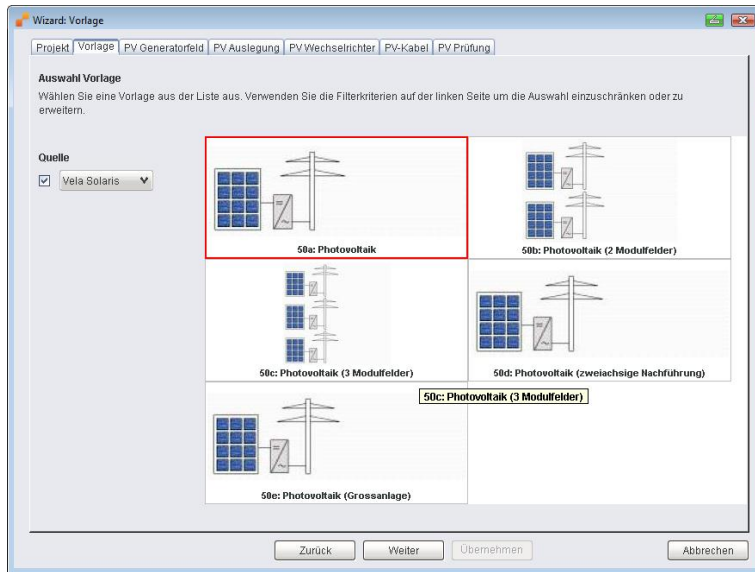

Step 3: PV system selection

Choice of small, medium or large PV systems

Accurate model for multi-string inverters, multiple mpp tracking, several independent collector fields

Option to apply fixed mounted PV or tracking (vertical, horizontal, biaxial)

Comprehensive model for photovoltaic-thermal (PVT) hybrid collectors

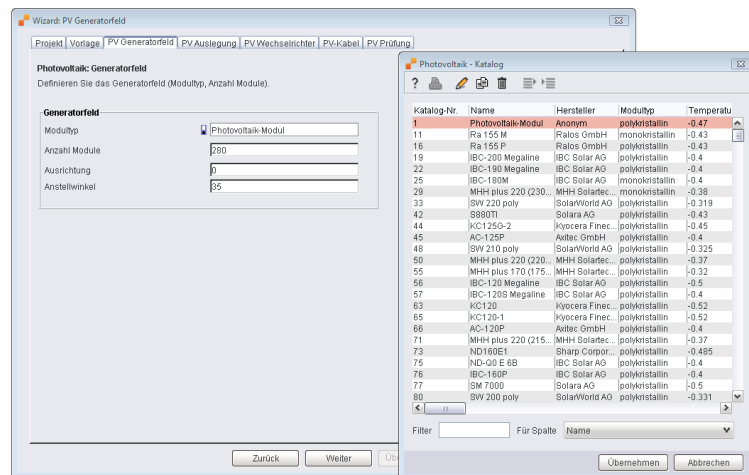

Step 4: System specifications

- Selection of module type from pop-up
- Entry of number of modules
- Selection of orientation
- Definition of work angle of the module

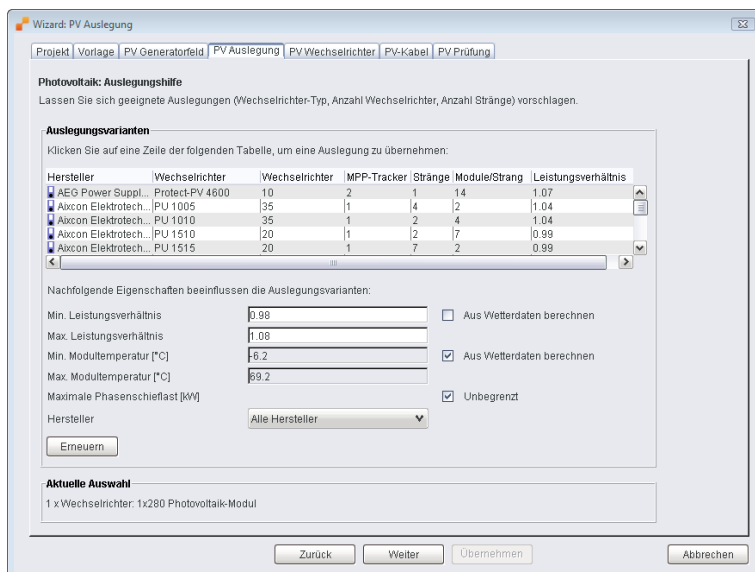

Step 5: System configuration

Module efficiency and system design is given automatically, but can also be entered manually

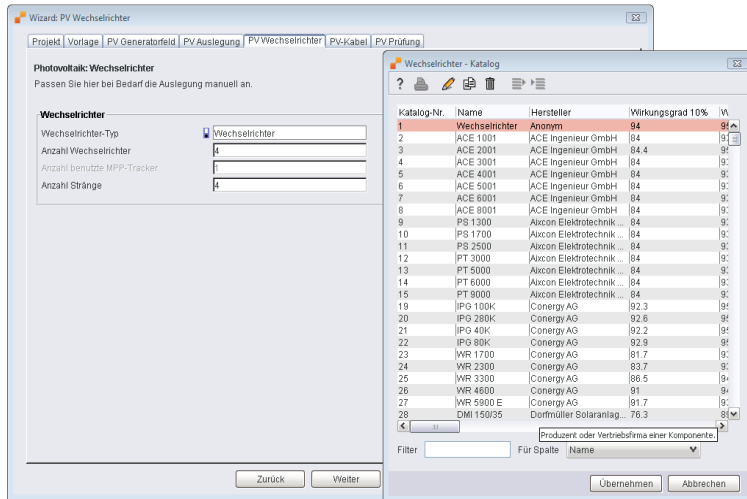

Step 6: Select inverters

- Selection of inverter type from pop-up
- Entry of amount of inverters
- Entry of amount of strand
- Comprehensive inverter database is maintained by Vela Solaris and delivered to customers through an automatic internet update

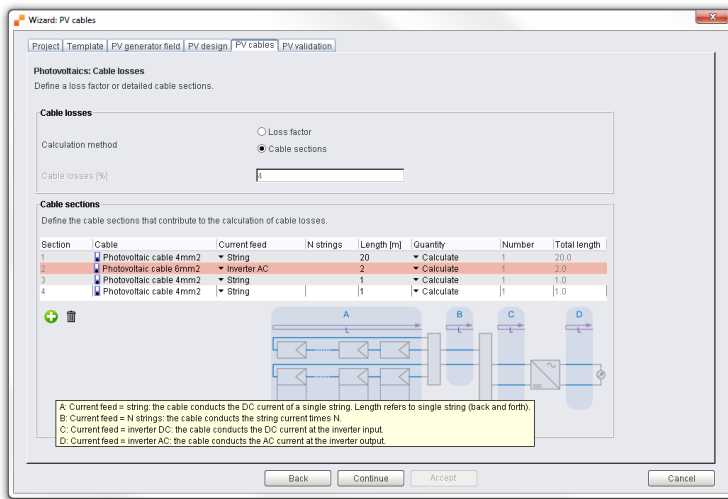

Step 7: System losses

Two alternatives

- Simple method: Entry of amount of cable losses (in %)
- Advanced method: Entry of cables with length of different sections and references to the cable catalogue

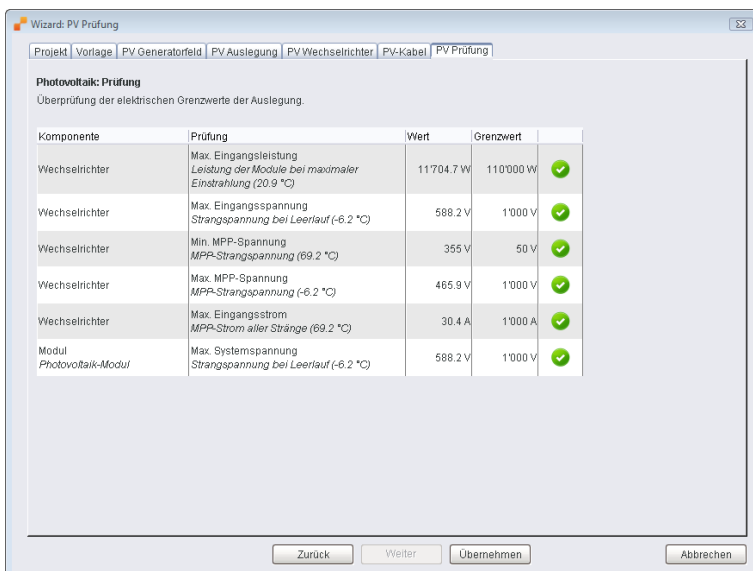

Step 8: System check:

system components are checked automatically

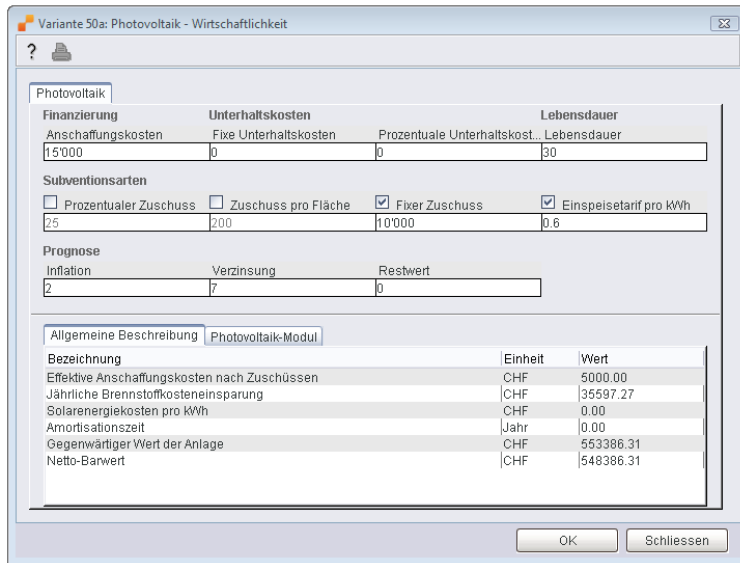

Step 9: Output

Polysun offers different results and analyses:

A) Efficiency analysis

- Effective cost of acquisition
- Annual fuel savings
- Solar energy cost per kWh
- Annual energy saving
- Amortization time
- Saved CO₂ emissions



B) System results

- Irradiation at module level
- Earnings photovoltaic DC
- Earnings photovoltaic AC
- Saved CO₂ emissions
- Performance ratio

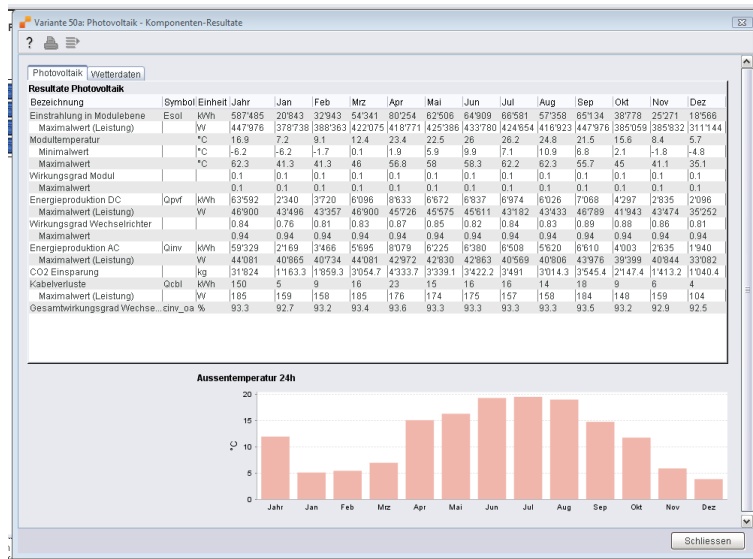

C) Component results

- Irradiation at module level
- Module temperature
- Module efficiency
- Energy production
- Inverters efficiency
- Saved CO₂ emissions
- Cable losses
- Overall efficiency

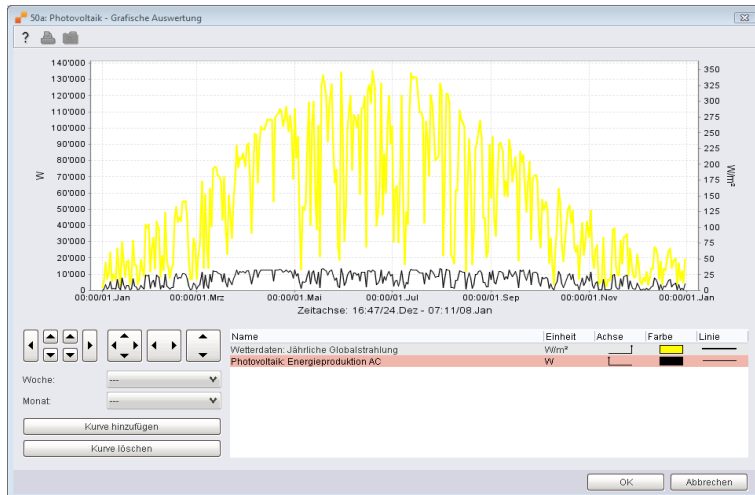

D) Graphical evaluation

Output can be generated for single and multiple curves on an hourly basis.

System variables include

- Weather data
- Storage space
- Energy earnings
- Module temperature
- Many more



E) Energy flow diagram

- Earnings: Photovoltaic DC
- Earnings: Photovoltaic AC
- Cable losses
- Inverters losses

All results and analyses can be exported in raw data for Excel or as professional reports in PDF format.

2.2.17. PVsyst

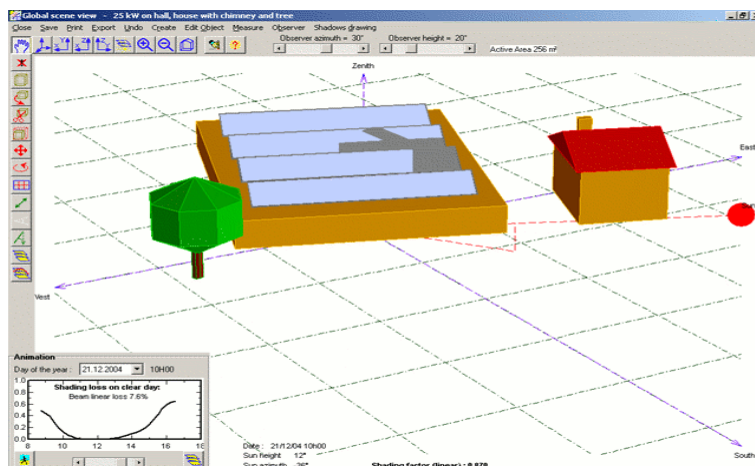

The PVsyst software program was originally developed by the Institute of Environmental Sciences (ISE) at the University of Geneva in 1994 and is now in its 5th version. The program is used for the sizing, simulation and data analysis of complete PV systems. It can be used to easily design and compare various systems, using several project levels.

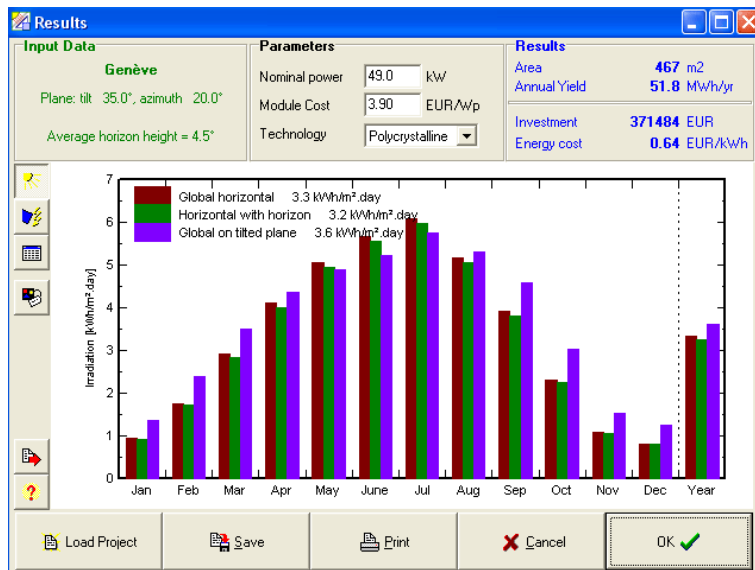

PVsyst is designed to be used by architects, engineers and researchers, and it is also a very useful pedagogical tool. It includes a detailed contextual help file, which explains in detail procedures and models used, and offers an ergonomic approach with regards to guiding the user in the development of a project.

PVsyst offers a preliminary design. It is an easy and fast tool, allowing for grid, stand-alone or pumping system pre-sizing. Based on the user's requirements such as energy/water needs and "Loss of load" probability and other basic input parameters, it provides the size of the PV-system component, evaluates the monthly production, performance, and performs a preliminary economic evaluation of the PV system.

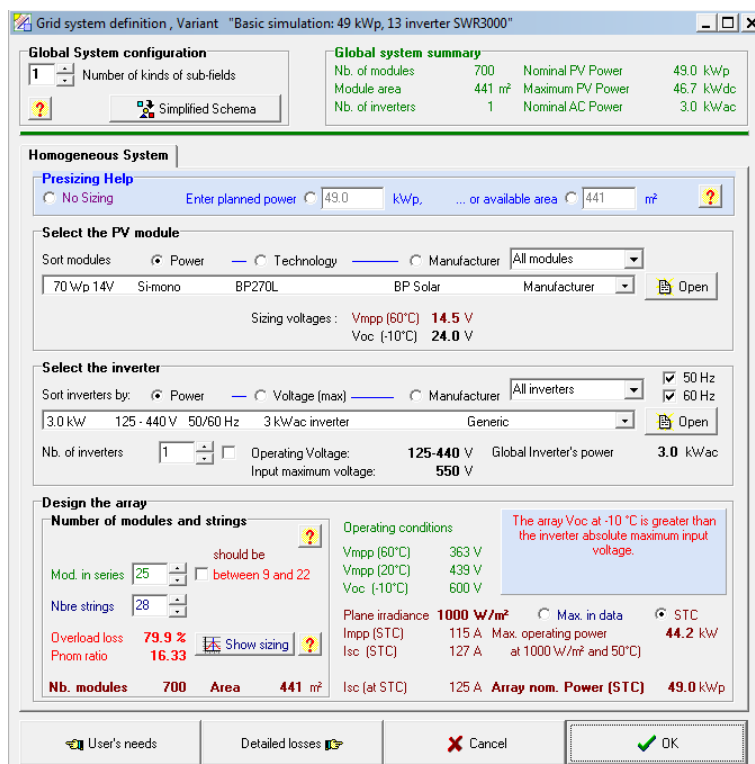

“Project design” performs detailed simulation in hourly values, including an easy-to-use expert system, helps the user to define the PV-field and to choose the right components. There is an extensive database of products which can be updated as required. The program guides the user through various iterative stages of complex definitions of the PV system and produces a complete printable report with all parameter and main results.

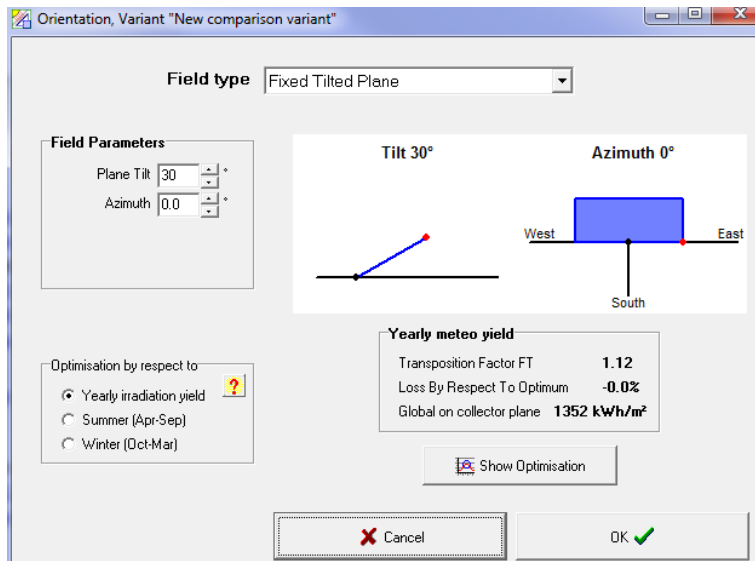

“Tool” performs the meteo (i.e. climatic data) and components database management. It provides also a wide choice of general solar tools (solar geometry, meteo on tilted planes, etc.), as well as a powerful means of importing real data measured on existing PV systems for close comparisons with simulated values.

*Note: the term “meteo” is used by PVsyst developer www.pvsyst.com

Solar shading analysis

Whilst PVsyst is a very sophisticated PV system simulation tool, the functionality for importing CAD models is limited. The 3D model construction ability is very basic to meet the needs of large scale PV assessments and basic building geometries. PVsyst however, allows for shade values to be imported from several sources:

The “Solmetric SunEye” instrument is a computerized instrument using a fisheye-type camera for the recording of the environmental masks. (www.solmetric.com , www.soleg.de). It provides a horizon height for each degree of Azimuth (i.e. 360 points).

“Carnaval” is a free open source software, which may be downloaded from www.incub.energie.free.fr. It is based on a geo-referred grid for calculating the horizon line at any place between longitudes 6°W to 10°E, and latitudes 41° to 52° N, therefore largely covering France, East of Spain, etc. It uses satellite data from the spatial US programme SRTM (Shuttle Radar Topography Mission), giving a grid of altitudes with a 3" resolution (about 92 x 65 m).

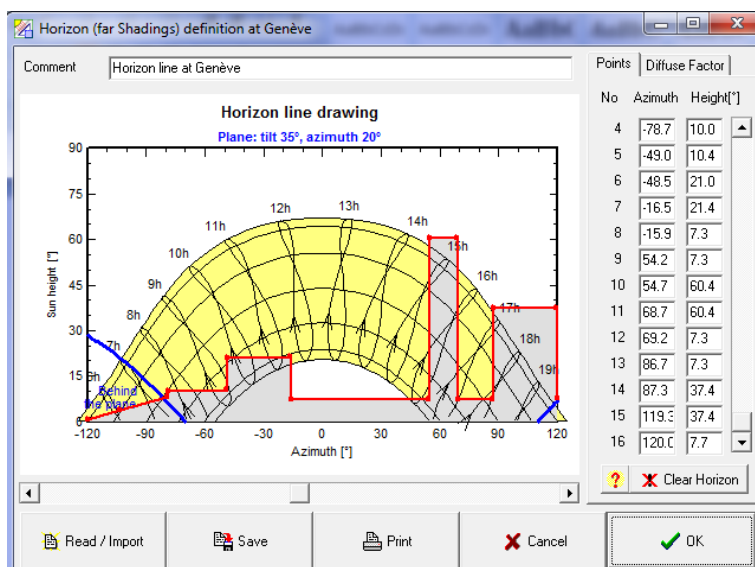

Horiz'ON software: this is to be used in conjunction with a specialized support for your Photo Camera, which allows to take several photographs with a horizontal reference (every 20° in azimuth), and gather them as a single panorama on which you can draw the horizon line by mouse (<http://www.energieburo.ch/web/en/products/horizon>). This produces a file with the extension “.hor”, which is directly readable in PVsyst.

A horizon file edited in EXCEL with the first column as Azimuth and the second column as Height, and saved as “.csv” file, will be valid after renaming it as “.hor”.

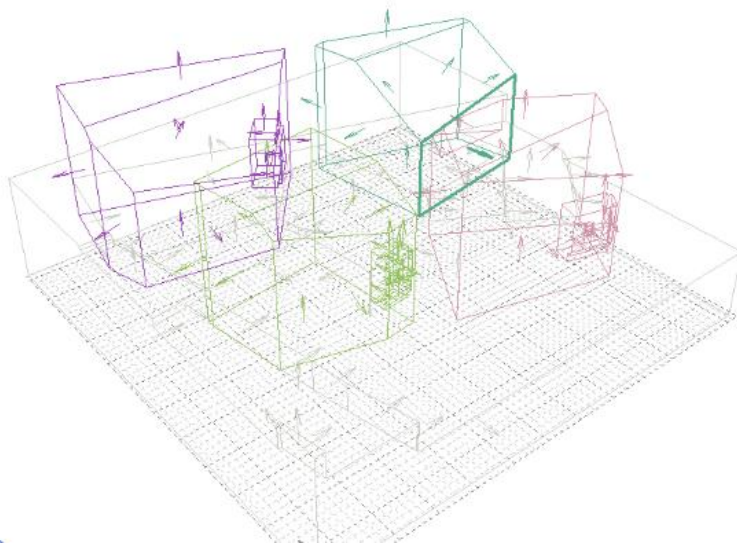

A more sophisticated approach is to generate the solar shading of a given surface by using existing CAD tools, such as SketchUp or AutoDesk Ecotect where the orthographic projection sky values can be produced and fed into the PVsyst model to more effectively account for solar shading.

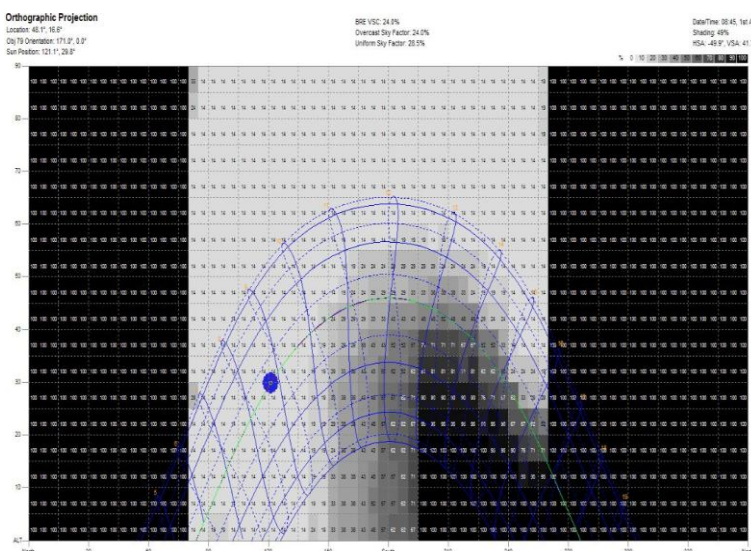
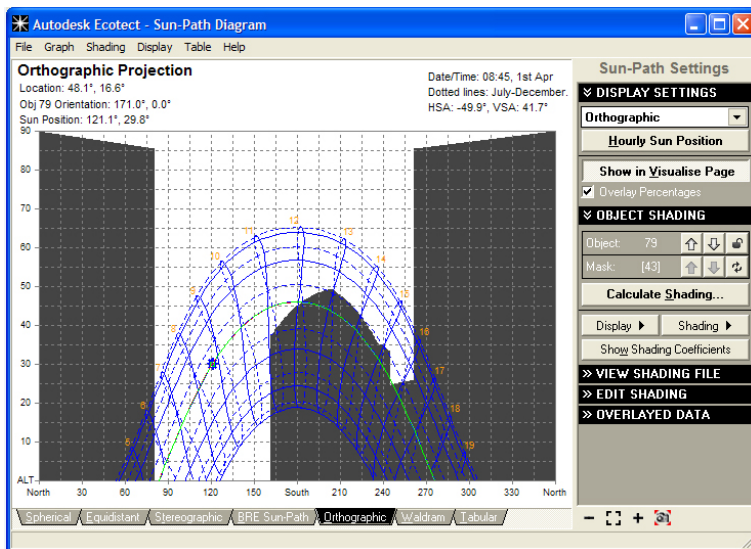

The orthographic projection which defines the hemispherical sky and shading from a given surface can be used to generate obscuration percentages of a defined grid size. These values can then be imported into PVsyst so that simulations can be run using a variety of user defined climate files, one of the most extensive PV module and inverter databases and a reputable sky modelling procedure. Whilst it was not possible in the basic global scene view to accurately replicate the building model, it is possible to use external CAD tools to generate the necessary external characteristics. The strength of the tool is the robustness of the PV system performance results. Clearly, this tool would be significantly enhanced if it was able to more easily interface with CAD models. The suggested work around is not particularly easy to undertake for an architect with limited PV simulation modelling expertise.

2.2.18. PV*Sol Expert 5.0

The latest program version is PV*Sol Expert 5.0. It is available in the following languages: English, German, Spanish, Italian, and French.

PV*Sol is a simulation program for photovoltaics. It is mainly designed for engineers and planners of photovoltaic systems. It requires very detailed data if reliable results want to be achieved. However, for the application at the Early Design Phase, first estimations are possible with the help of default inputs.

In general there are two options for the simulation: one is to use a 3D model and the other one is to simulate without PV*Sol internal visualization and using the add-in "Photo Plan". Both options permit a detailed PV system (including also inverters and interconnection between the modules) sizing for feed-in systems, stand-alone system, and surplus feed-in systems. The simulation is done for one year based on hourly weather data. PV*Sol comes with worldwide weather data.

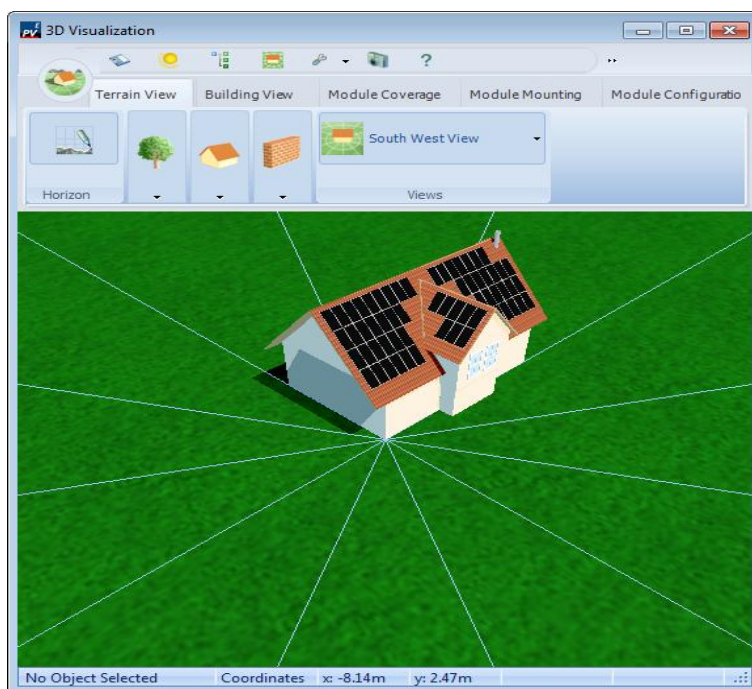

3D model

It is possible to make a 3D model of buildings based on rectangular forms with different options for roof types. Drawing complex, "modern" structures as the example buildings used in the rest of this report is almost impossible. There is no import of CAD-files. The building has to be reconstructed in PV*Sol. This is made basically with the help of building blocks. There are different possible roof types which can be edited depending on the project. Shading objects like buildings or trees can be easily added and edited in the 3D model.

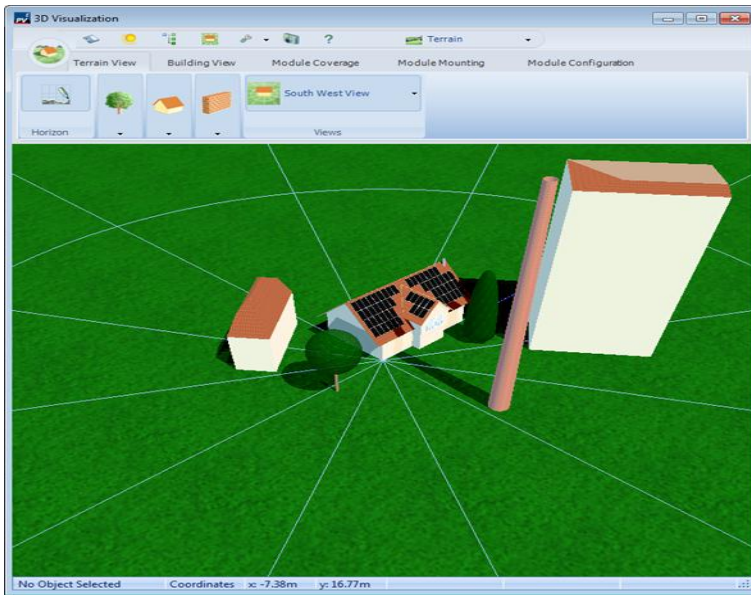

Once the building is entered into PV*Sol, a PV module can be selected from a broad database and added to the building by drag & drop. There is a function to automatically put every possible module on certain surfaces.

The figures show an example for a simple building model in the 3D visualization. Building elements like dormers, chimneys and shading objects can be selected in the element library and added to the project via drag & drop.

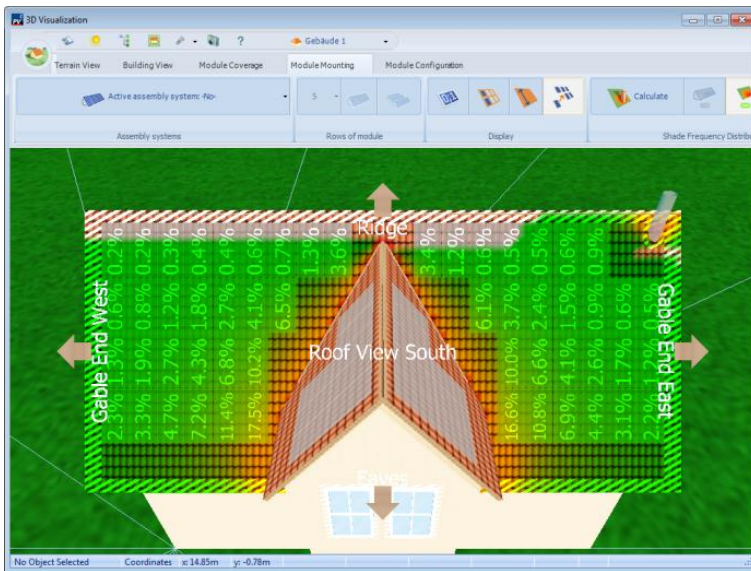

A shading analysis can be performed. As result the percentage of time during which the different modules are shaded is given visually, like shown in the next two figures.

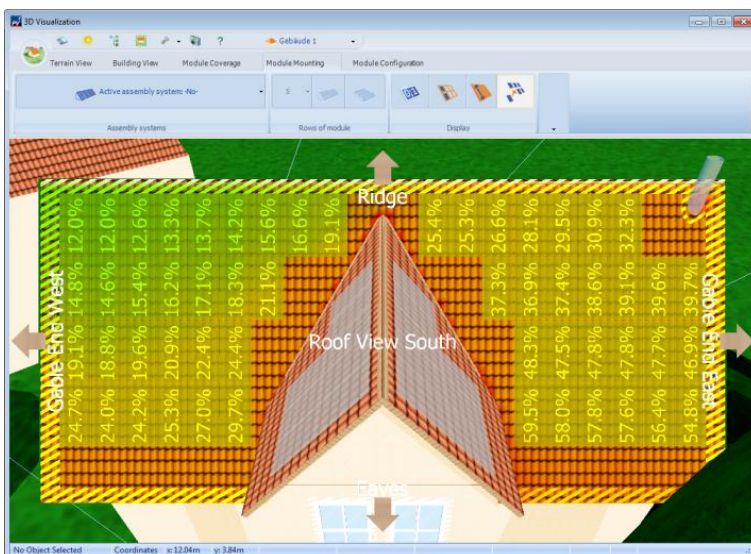

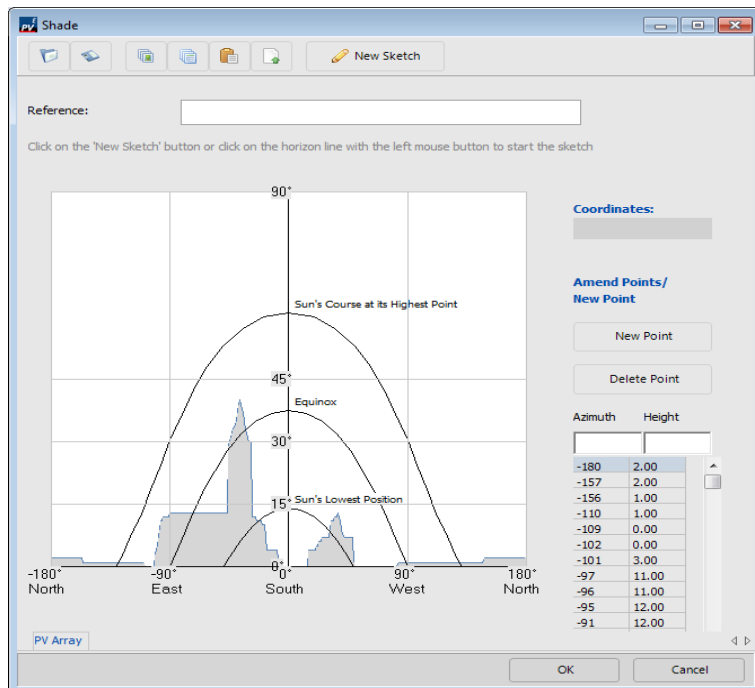

Alternatively to adding the shading objects in the 3D model, it is possible to define them with the help of a classic sun-path diagram.

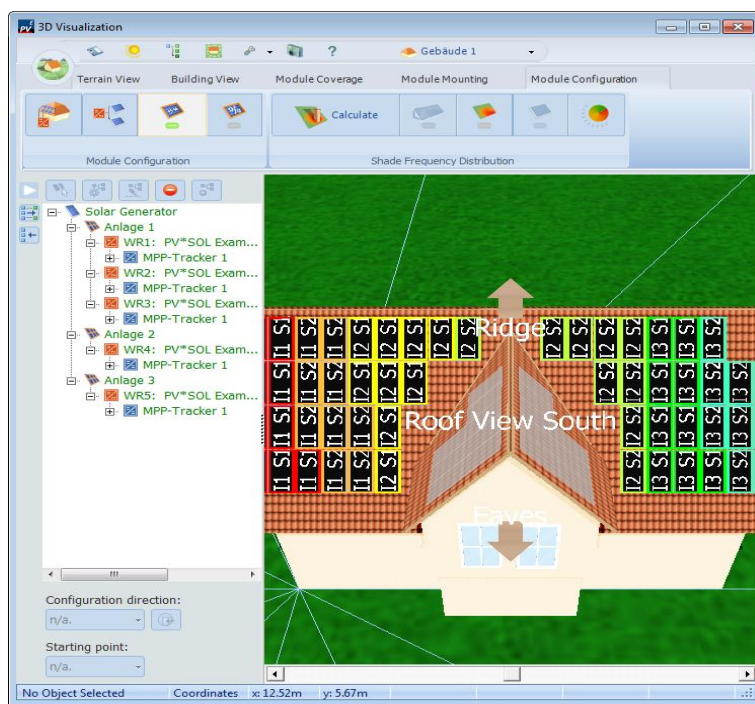

PV*Sol helps with the selection and visualization of inverters and interconnections between the modules.

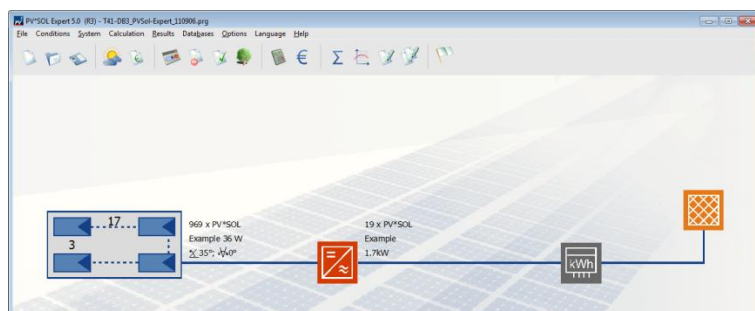

Without 3D model

Without the 3D building model, there is only a schematic visualization of the PV system like shown in the figure. The geometric data has to be entered manually.

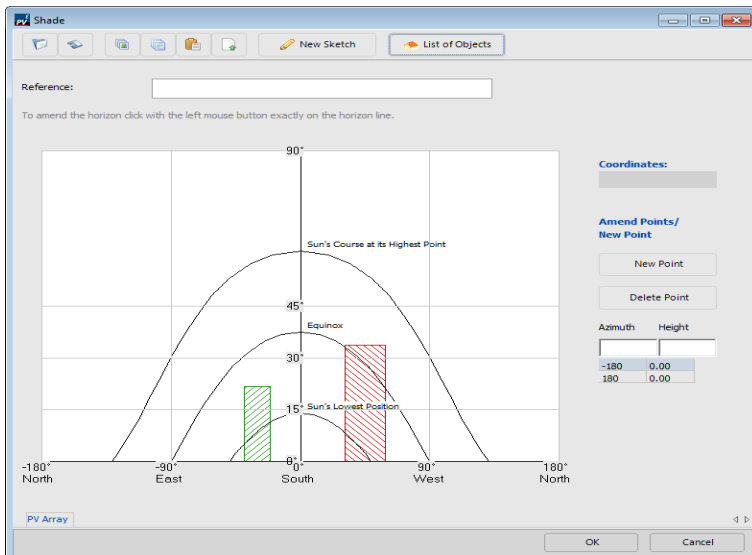
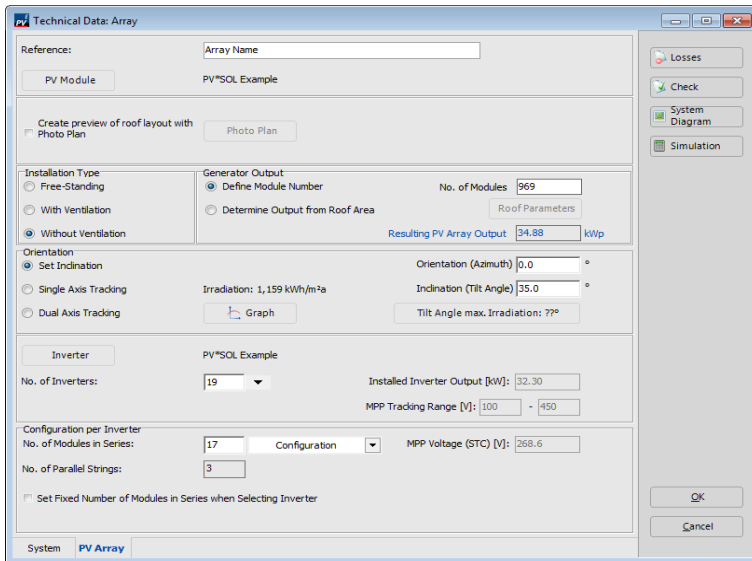

Shading can be included in the calculation by using the classic sun-path diagram

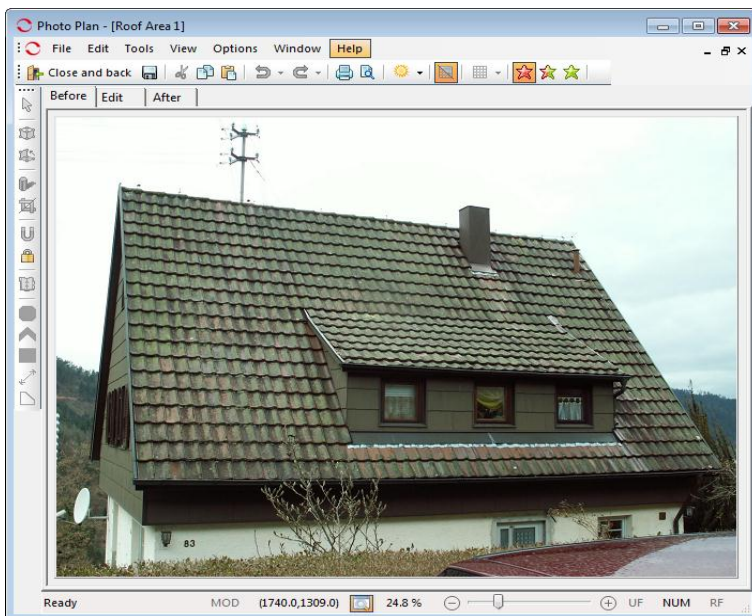

There is an Add-on for visualization of PV systems: "Photo Plan". The rendering of the PV system is done on a photograph of the building, so it is suited for existing buildings. Only few data are necessary, but areas and angles have to be defined. Some practice is required to accelerate the visualization process. The function to automatically put every possible module on a certain area is also available for Photo Plan.

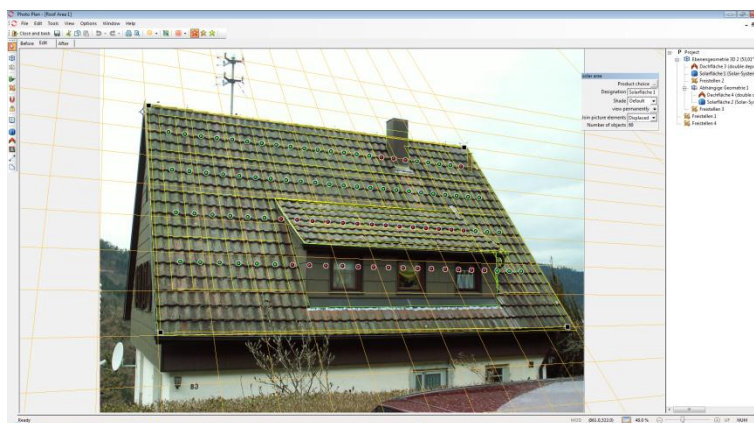
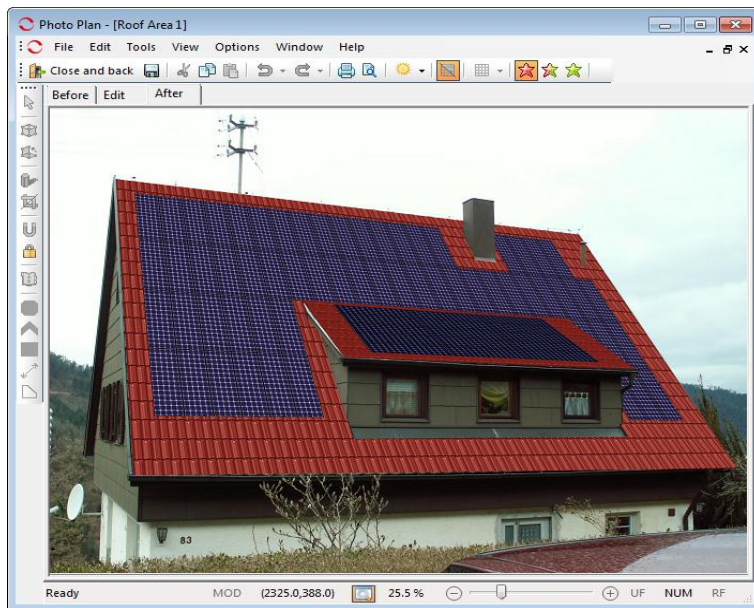

Output

1. Shaded areas and percentage of time during which a module is shaded (3D model)
2. Yearly power generation
3. Performance of the PV system
4. Losses of the PV system
4. Used weather data (temperatures, irradiation).

The results can be visualized in diagrams that can be edited individually and can also include some input data. Diagrams can be visualized for a whole year, a month, a week or on daily basis. Detailed tables with all data can also be generated. There is a standard project report that includes the most important information about the simulated system and the calculated results.

A detailed economic efficiency analysis, which is able to include feed-in tariffs, can be made.

2.2.19. T*Sol Pro 5.0

The latest version is T*Sol Pro 5.0. It is available in the following languages: English, German, Spanish, Italian, and French.

T*Sol is a simulation program for solar thermal systems. It is mainly designed for engineers and planners of solar thermal systems. For application during the Early Design Phase too many detailed data are required if reliable results want to be achieved. With the help of standard-inputs, first estimations are possible.

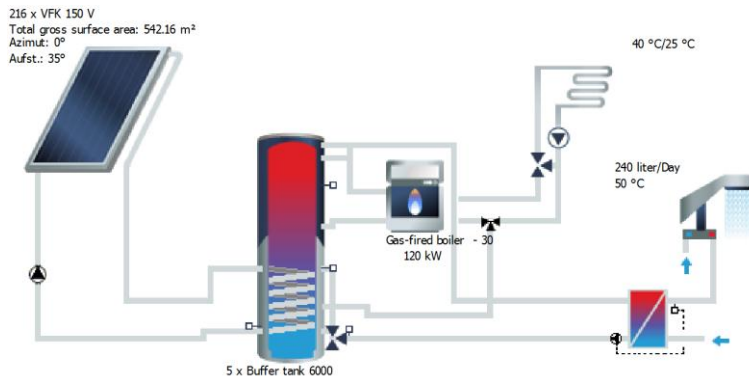

There is no customized visualisation, only technical schemes with different icons depending on the simulated system. The distribution of the collectors on the surfaces has to be done separately.

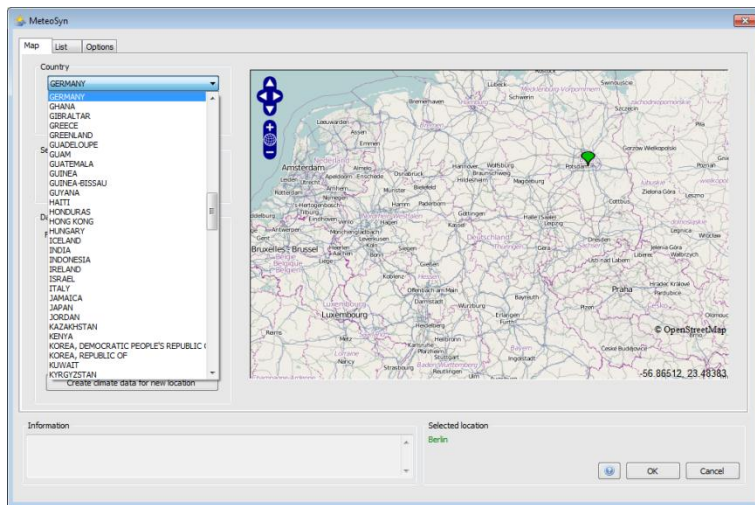

The simulation is done for one year, based on hourly weather data. T*Sol comes with worldwide weather data.

The necessary required area for the solar system is defined, besides its geographical location, by its size, slope and azimuth.

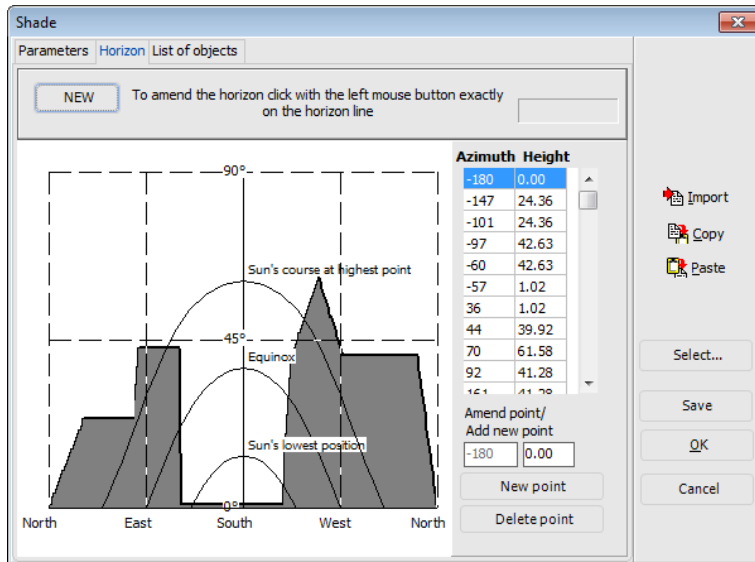

Shading due to surrounding objects can be entered using the classic sun-path diagram. Shading caused by close objects like e.g. an overhang can be defined with two angles.

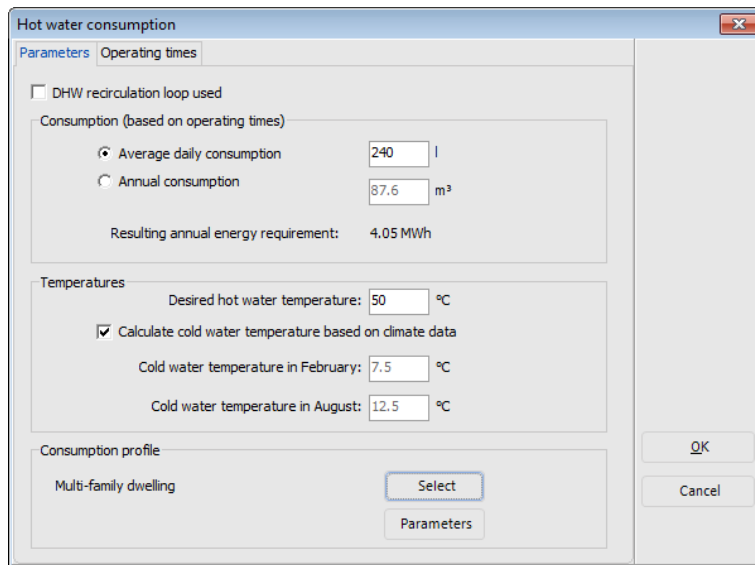

Different types of solar systems, depending on the utilization of the generated heat, can be simulated:

- Domestic hot water
- Space heating
- Process heating

Also the common solar thermal technologies can be simulated. T*Sol comes with a huge product data base, but it is also possible to edit new collectors.

- Flat plate
- Vacuum tube
- Swimming pool
- Air collector

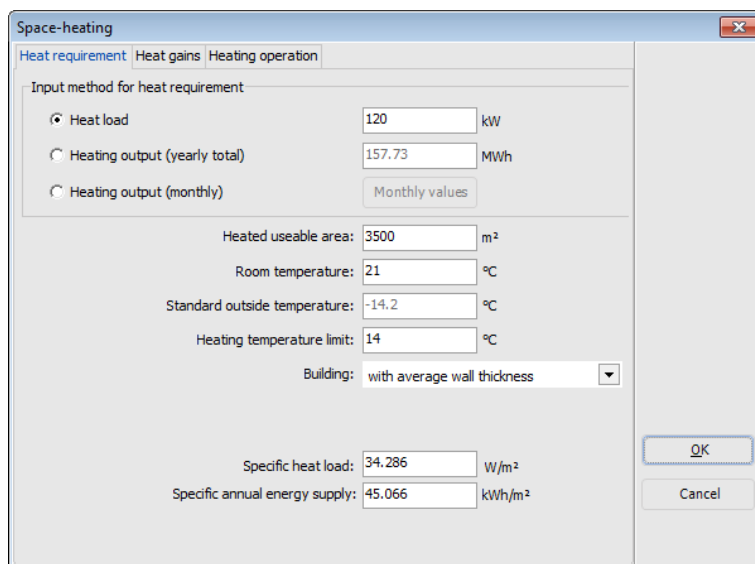

A database for storage tanks and non-solar heating systems completes the definition of a solar thermal system.

For the heat demand side numerous inputs are possible, but also required if meaningful results are wanted. For first estimations the standard values can be applied.

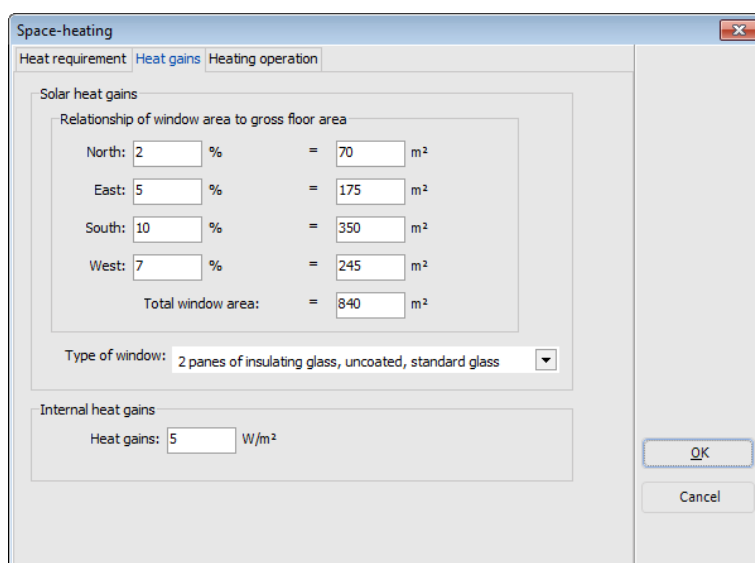

The knowledge of the hot water or space heating demand is essential in order to dimension the different parts of the solar system and in order to get results like e.g. solar fraction.

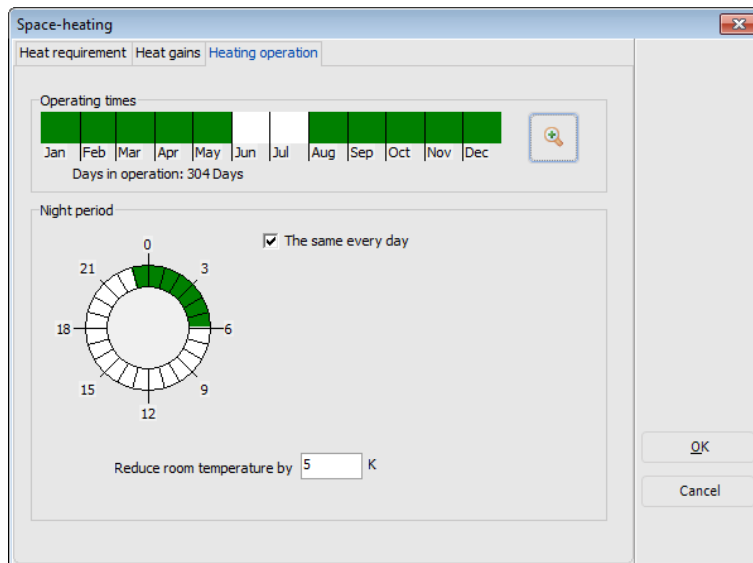

There are many options to enter users' profiles using detailed timetable options (left and the following image).

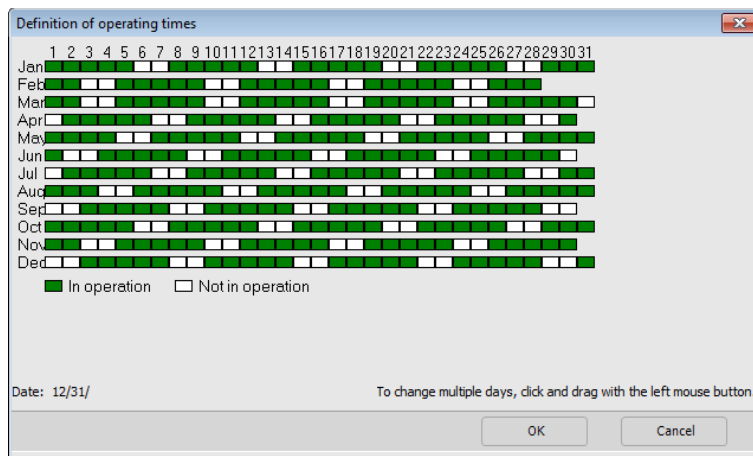

Some of the possible outputs are:

- System efficiency
- Total solar fraction
- DHW-consumption
- Energy requirement for heating and DHW
- Irradiation onto active solar/gross surface area; shaded/unshaded
- Collector (loop efficiency, outlet temperature, temperature)
- Different losses (optical, tank, thermal collector, circulation, internal & external piping, etc.)
- Global radiation – horizontal
- Outside temperature
- CO₂ emissions avoided

The results can be visualized in diagrams which can be edited individually and also include some input data like e.g. DHW-consumption. There is a standard project report which includes the most important information about the simulated system.

A detailed economic analysis can be made.

3. EXEMPLARY CASE STORIES

This section of the report will present three exemplary case stories where different methods, i.e. design approaches and solar design tools were used. The aim of this section is to demonstrate that a successful final result can be reached through various means and levels of collaboration between actors in the design process, and to, hopefully, encourage all participants of the design team to open to innovative design paths.

3.1. Kuggen building, Gothenburg, Sweden

Architect: Wingårdhs architects

The client assigned the architect in 2006 and the building construction lasted from November 2009 to the summer of 2011. The building is located on a square close to the sea, on a location where the Chalmers University of Technology in Gothenburg meets the industry and will host around 4200 square metres of offices.



Figure 6: Kuggen Building, Chalmers University of Technology, Gothenburg, Sweden. Image source: Wingårdh arkitektkontor.

3.1.1. Tools used

In this project, when the first proposals were made, the architects made sketches, built EPS models, 3D CAD models and visualisations. In later design stages, simple rules of thumb were used by the architect, such as the guideline of having roughly 25-30% of glass surface in the façade in order to avoid solar gains overheating and glare while still achieving adequate daylighting levels.

The building service engineer used mainly the Swedish building performance simulation (BPS) tool IDA 4.0. Calculations of the building service engineer were based on 3D models made by the architect. Output files in form of pictures and tables were sent from the building service engineer to the architect. In such a way, the impact of different design options were visualised and calculated, which made it easier to choose one option based on evidence.

3.1.2. Methods (process)

The architect described the design process as being “a normal design process”. In the beginning, it was unclear which function the building would have; it was known that the building would function as a meeting place, would be located on the square and that it would be 4 to 5 floors high. Later in the design process it became clear that the building would be an office. In the first phase, the architects developed several proposals and they did that by sketching, making EPS models and by visualising them. At that time, the integration of solar energy was not a main focus in the project.

In the next phase, the building’s form was developed in such a way that the plan looked like a cog, with an office room in every ‘tooth’. The building had 156 ‘teeth’ and all of them appear the same. According to the architect, this cog form was developed to make a smart building, to fit on the site and to achieve good floor ratios. However, this shape also means that it is hard for building services to follow this form since it is not straight. Every floor cantilevered, which meant that thermal bridges became a big issue, and the building’s façade was still almost totally in glass.

At that moment, the building service engineer came in, and stated that the building would not pass the new building regulations and the additional standards. The client also started to put a focus on sustainability. This new focus and the involvement of the building service engineer made that the building proposal had to change. This change mainly concerned the size of the windows and a solar shading system. Furthermore, solar panels were considered to provide electricity for the building, but were not seen as aesthetically attractive by the architect and ended therefore at the roof out of sight.

3.1.3. Aesthetic aspects through tools

The building service engineer has had a major influence on the building’s form during the design process. The energy calculations performed by the engineers in IDA-ICE showed that with the proposal at that time, building regulations and additional standards would not be met. This was mainly due to the fact that the building proposal had too much glass. Daylight calculations, also done in IDA, showed high values and high contrasts of daylight levels in the building. The building engineer therefore proposed to lower the amount of glass and to take into account a properly designed solar shading system in order to prevent the building from overheating and daylight problems.

In the beginning, the architect included awnings in the building, but they would blow in pieces out there. The client had at that time been in Germany and had seen a moving solar shading device and

was inspired by this. The architect went to see this building as well and concluded then to make moving solar shading from a lighter material than the one in Germany. The solar shading has been subject of many discussions, within the architectural office and with the building service engineers. Within the architectural office, the idea of having solar shading has been questioned because of its aesthetics. When the architect found out that solar shading was necessary, several proposals were done and calculated and discussed with the engineer. The engineer made the calculations in the BPS tool IDA-ICE. Important factors in this discussion were the size of the solar shading, the effect on the cooling load, the material, and the tenant's experience and possibility to look outside. In the last phase of the design process, the architect decided that the solar shading should have a grid, which allows the tenants to still look outside, while blocking the majority of the solar radiation when the sun has its biggest impact. The shading is automatically moved, depending on the position of the sun.

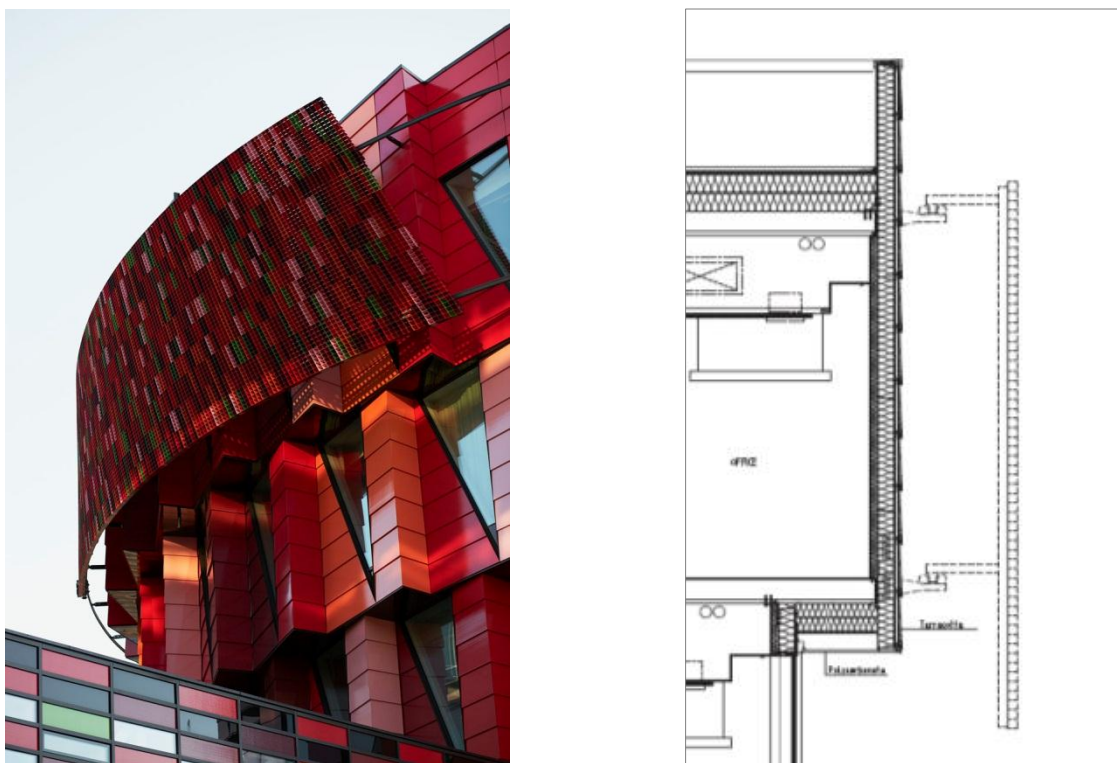

Figure 7: Exterior shading element (left) and construction façade detail (right). Image source: Wingårdh arkitektkontor.

3.1.4. Technical aspects through tools

The building service engineer provided the architect with necessary information about the energy performance of the building, and the effect of several design choices on the energy performance and comfort in the building as well. The consultant also chose the building's technical systems.

After the first set of proposals, the building got its final shape, and the building service engineers chose a technical system for the building, i.e. the ventilation, heating and lighting systems. In this case, a motion-based system was chosen, with sensors in every room. The initial proposal to base

the whole system on such sensors was turned down by the architect, who wanted the tenants to have more control over his / her environment.

After the architects decided to cantilever each floor more on the south side of the building in order to provide shadow to the floor below, the building service engineer performed calculations which showed that this would only be efficient for the first two floors, which are additionally shaded by the surrounding buildings. However, cantilevering in such a way has its disadvantages; the building service engineer noticed that the building had problems with all thermal bridges (if not taken care of).

For every design option, the building service engineer performed an energy balance calculation. According to the architect, the building service engineer was more or less forced to do so, but the calculation could be performed rather quickly. The initial energy analysis done by the building service engineer resulted in a yearly energy use for the building of 72.8 kWh/m²/year. According to the building service engineer, this is with a safety margin of 15% due to the fact that many factors were based on assumptions and that the result is legally binding. In a correspondence between the architect and the building service engineer, it is said that the client addresses concerns about this value; they were afraid that the building was performing too well and that the tenants are neglected.

The design of the solar shading has been an issue during the design process, which needed much attention from both the architect and the building service engineer. After having performed the first energy balance calculation, the building service engineer told the architect that without proper solar shading, the building would not comply with the requirements because of overheating. The engineer proposed to choose an ordinary solar shading system. The architect realised that they were forced to have solar shading, but also that it would have a big (aesthetic) impact on the building. The architect therefore proposed several solar shadings, which were analysed by the building service engineer. Since the solar shading was not a standard one, the building service engineer had problems with calculating the efficiency of it; a complicating factor for instance was the fact that the solar shading rotates. The way of communication was normally as follows; the architect provided the geometry and material features of the proposed solar shading, the building service engineer provided tables and figures in return, which presented the effect of the solar shading and in such a way helped the architect to decide on the most suitable proposal.

3.1.5. Economic analysis

The property owners were focused on getting the energy performance of the building up to the 'Green Building standards'. In that case, they would be able to show their involvement in 'sustainable building'. However, this also implicated that the building would be more expensive than a regular building. In this building, additional effort (and costs) regarding sustainable elements was put on the solar shading system, insulation levels, ventilation system, a geothermal heat pump and solar cells. In this way, the building would receive the Green Building Certificate.

3.1.6. Barriers to use solar design tools from the architect's perspective

The architects did not use any BPS tool during the design process. They all relied on the competence and knowledge of the building service engineer and did not have or take the possibility to calculate different design options themselves. This has probably slowed down the process several times.

Furthermore the architect, while designing a new window configuration, could not calculate how it would affect the energy performance of the building.

3.2. Eugene H. Kruger building, Quebec City, Quebec, Canada

Located in Quebec City, Canada, the Eugene H. Kruger is the building of teaching and research in engineering wood, located at Laval University campus. Inaugurated in September 2005, the overall design intent for the project was to demonstrate the potential of all-wood large scale construction and to achieve principles of sustainable development relating to comfort of occupants, energy efficiency and durability of building (Potvin and Demers, 2007).

3.2.1. Tools used

The CAD tools used were mainly AutoCAD and Form•Z from conceptual phase until construction drawing phase. AutoCAD was used to draw 2D building models and redraw some rough sketches made by hand drawing. Form•Z was rather used to draw 3D building models and visualize the project (Figure 8). Both AutoCAD and Form•Z were run by the architectural office. The Table 1, below, shows the Building Performance Simulation (BPS) tools used during the design process. All simulation tools were used by the research group in physical environments (GRAP), especially during the brief design and concept design phases.

Table 1: Building Performance Simulation (BPS) tools used for various aspects of the design of the Eugene H. Kruger building

Brief design	<i>Creation of Lumcalcul tool (Demers and Potvin, 2004)</i>	Used to analyse the daylight factor and to size the width of the skylights
Concept design 	<i>ATHENA</i>	Used to calculate the life cycle of materials and to convince the owner to use a wooden structure
	<i>Artificial sky of the Laval University</i>	Used to analyse the daylight factor, qualitatively analyse the quality of daylighting and calibrate some parameters of Ecotect
	<i>Ecotect</i>	Used to analyse the daylight factor and the impact of the reflectance of materials
	<i>Pilkington method</i>	Used to calculate the optimum angle of the sun shading devices
	<i>PET4.10 (Potvin and al., 2004)</i>	Used to analyse thermal variables inside the building
	<i>BSim2002 Energy-10 version 1.5</i>	Used to analyse the energy consumption of the building and analyse specific places that could overheat in the summer, etc.
Construction design	<i>EE4</i>	Used to analyse the building's energy consumption to validate the energy prerequisite by LEED®

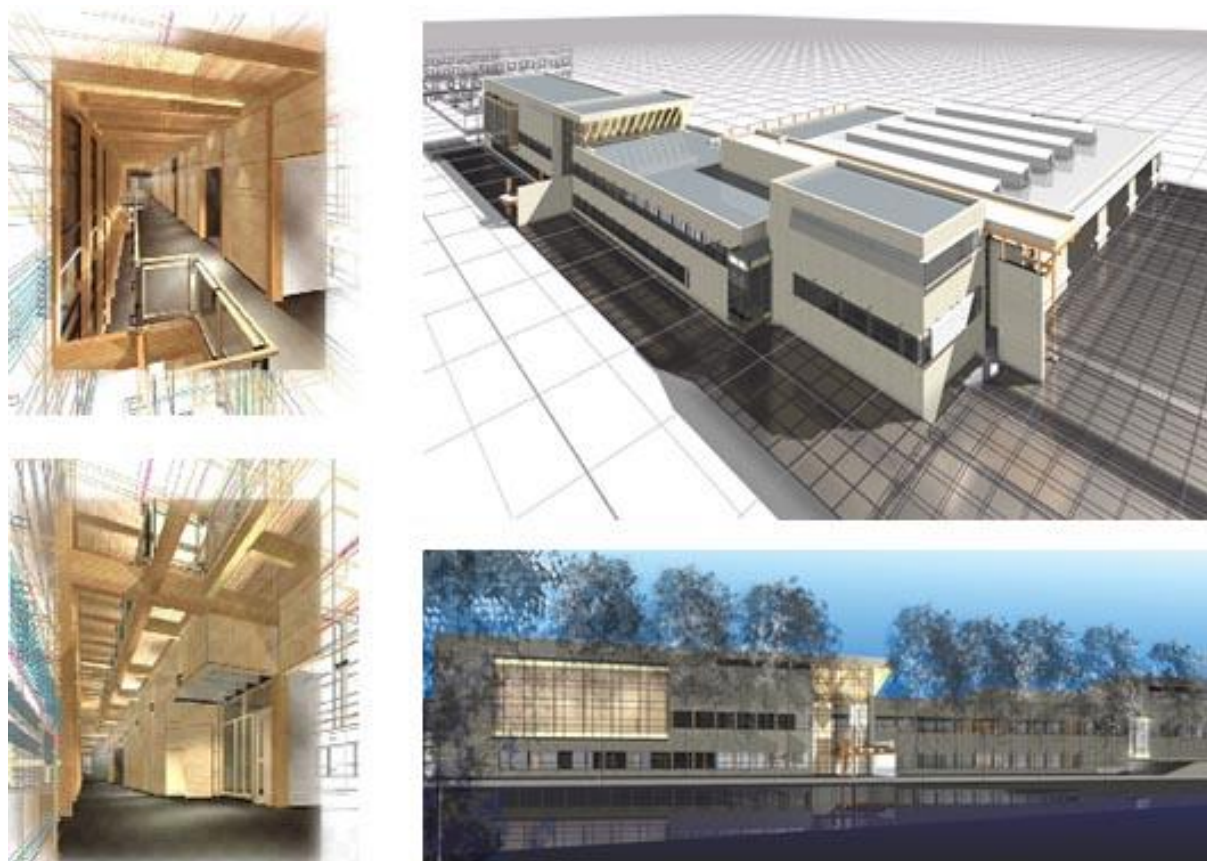

Figure 8: Presentation drawings made with Form•Z by the architectural office (Source: Laurent Goulard)

3.2.2. Analysis through tools

Both thermal and daylighting simulations were done during the design process. Simulations were conducted to satisfy thermal and lighting needs and establish possible energy savings by the various bioclimatic strategies (Potvin and Demers, 2007). Initially, daylight simulations were conducted to assure a good level of comfort and to evaluate prototypes of skylights about their configurations, sizes and internal surfaces. Some of the results were qualitative, showing interior views with different shapes of the skylight (Figure 9). In addition, the Pilkington sun angle method, validated using the artificial sky, presented here in Figure 10, was used to design different types of sun shading devices made in frosted glass and installed on the exterior walls. These methods were used to calculate the angle and the position of the sun-shading devices to allow solar heating in winter and to block the excessive sun and glare at the end of the afternoon. All shading devices were also designed to limit overheating in summer. The look of exterior shading devices is presented in Figure 11, p. 97.

Thermal simulations were carried out then, with the software Energy-10 to show the overall energy consumption in kWh/m². Figure 12 shows two simulations and shows that even if heating increased in the second simulation, it is because the simulation considered the opening windows, which compensated for the absence of air-conditioning load and moreover, by the daylighting performance. According to Potvin and Demers (2007), thermal simulations were based on approximate values available at the time, presented according to their importance:

- modification of the openings (size) to allow a better contribution of daylighting;

- thermal performance of glass of the windows;
- installation of sun shading devices;
- insulation of the envelope which exceeded energy code standards by 50%.

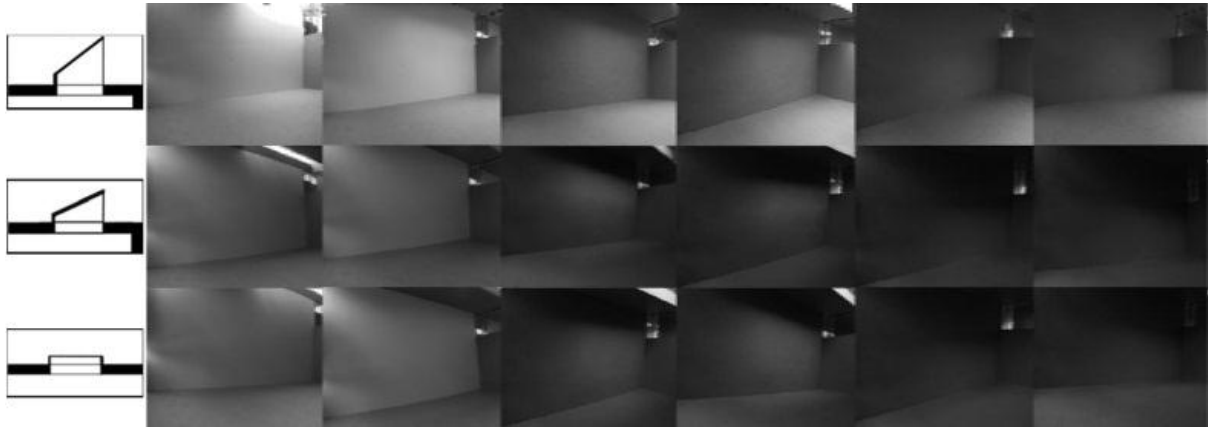

Figure 9: Qualitative results made with the artificial sky at the School of architecture of Laval University by the GRAP (Source: Potvin and Demers, 2007)



Figure 10: Simulation made with the artificial sky at the School of architecture of Laval University made by the GRAP (Source: Potvin and Demers, 2007)

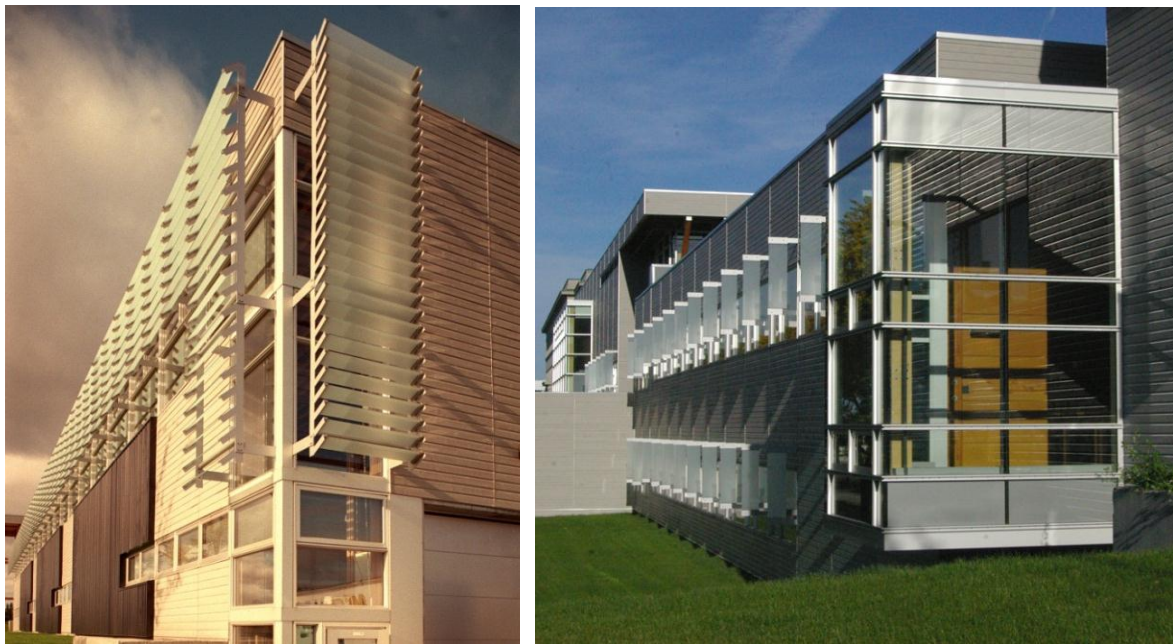

Figure 11: Custom fixed exterior sun shading devices used in the building (Source: Laurent Goulard)

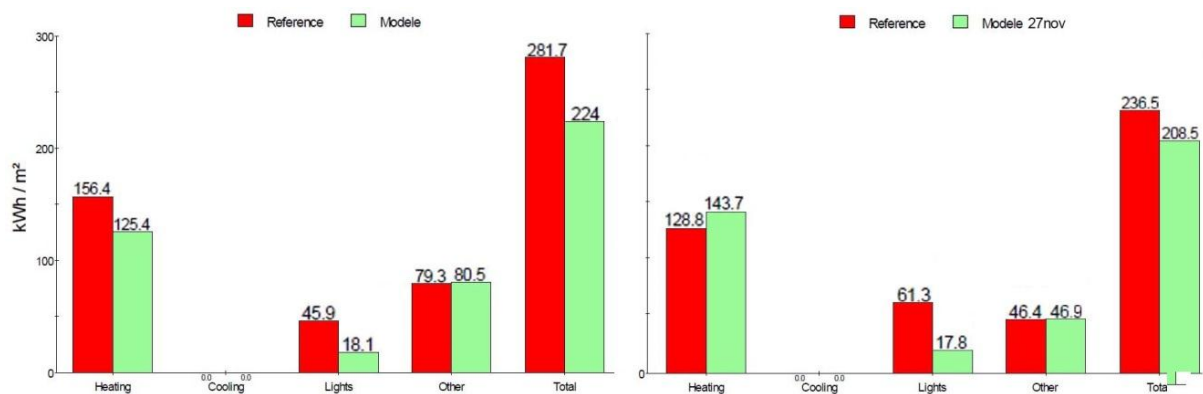

Figure 12: First and second simulations made during the process of design by the GRAP showing the energy consumption for the heavy laboratory section in kWh/m2 (Source: Potvin and Demers, 2007)

3.2.3. Methods (process)

The building was designed by Gauthier Galienne Moisan Architects who had worked with environmental consultants in physical ambiances, the GRAP, from the very beginning, starting with the tender which specified such relevant elements of sustainable development. The GRAP includes two professionals which are André Potvin, specialist in thermal environments, and Claude Demers, specialist in daylighting. These professionals were notably in charge of chairing the meetings, the design workshops, which generally included the following actors:

- owner (members of Laval University);

- architects' teams;
- engineers (structural, mechanical and electrical);
- consultants (code, elevator and architectural lighting);
- general contractor.

The design team also received a 2004 ConTECH mention in Sustainable Design for their integrated design process (IDP). The different phases of the construction process for the building were conducted between 2001 and 2005 (Figure 13).

	November 2001	June 2002	July 2002	August 2002	September 2002	October 2002	November 2002	December 2002	January 2003	February 2003	March 2003	April 2003	May 2003	June 2003	July 2003	August 2003	September 2003	October 2003	November 2003	December 2003	January 2004	February 2004	March 2004	April 2004	May 2004	June 2004	July 2004	August 2004	September 2004	October 2004	November 2004	December 2004	November 2005	
Brief Design	■	■	■	■																														
Concept Design					■	■	■	■	■	■	■																							
Construction Design									■	■	■	■	■																					
Construction																																		

Figure 13: Phases of pre-design to construction

At first, a brief design phase began with various agreements taken by the owner (Laval University). These agreements included funding, initial program, future site and the objectives of the project. The objectives were: (1) the use of wood to demonstrate its full potential and (2) the development of the first building on campus according to criteria of sustainable development and to bioclimatic architecture, with particular attention to daylighting and operational energy cost. According to André Potvin, the objectives were therefore to provide the environment for occupants as comfortable as possible while minimizing energy consumption. Moreover, according to the architect André Moisan, one of the aims of the project was also to align the design process with LEED®. Finally, these goals implemented by the project team guided the design process.

Secondly, the concept design phase began with several types of studies:

- Implementation on site;
- Integration of bioclimatic strategies that exploit natural energy;
- National Building Code requirements;
- LEED® elements

A first set of plans, elevations and sections were then drawn. Figure 14 shows the first iteration, showing a different "L" shape, a higher building height and use of many thermal and daylight "chimneys" as well as an implantation proposal (i.e. proposal of species and position of vegetation and trees around the building that would support passive solar design). Following discussions with the owner, a second set of plans were drawn and accepted (Figure 15). This second series include again the idea of the "chimney", but this time in a single, large chimney, extending the length of the building. According to Laurent Goulard, all the design options intended to keep the basic concept of a wooden volume punctuated by horizontal strips and transparent prisms that would expose the occupants' activity as well as emphasize the building structure of exposed wood.

Thirdly, the preliminary and final phase concerned the development of bioclimatic systems and representations for presentation purpose (Figure 16). The concept of the "chimney" was realized by

the skylights as well as the high-level entrances and circulation areas. The final plans, elevations, sections, etc. were then drawn (Figure 17).

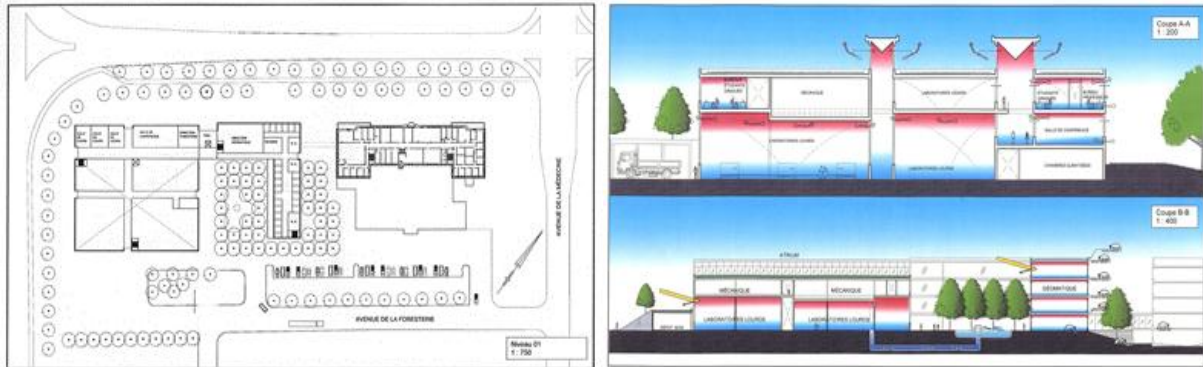

Figure 14: First organization plans made by the architectural office in collaboration with the GRAP (Source: Laurent Goulard)

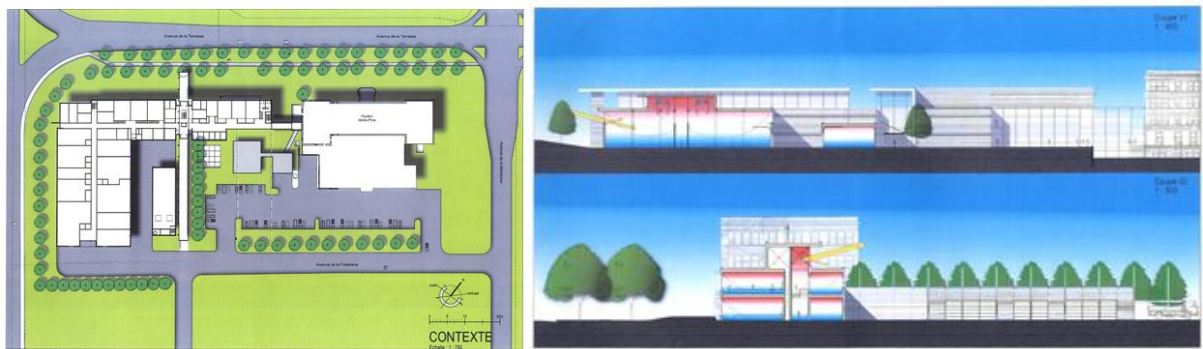

Figure 15: Second set of organization plans made by the architectural office in collaboration with the GRAP (Source: Laurent Goulard)

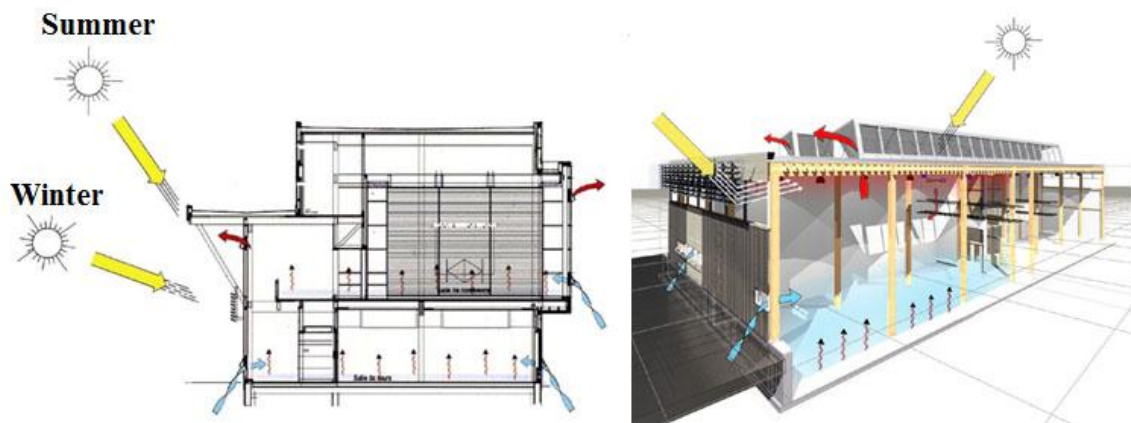

Figure 16: Final drawings: Bioclimatic strategies (Source: Laurent Goulard)



Figure 17: Final drawings: The building on site with the implantation plan (Source: Laurent Goulard)

3.2.4. Aesthetic aspects through tools

One of the special features is the judicious integration of solar aspects. Passive solar heating strategies have been used through the building form, combined with an active solar technology. These strategies have been illustrated through Form•Z, used by the architect team, notably the SolarWall® integrated in the south-western façade, the sun shading devices integrated on the façades and the skylights (Figure 18).

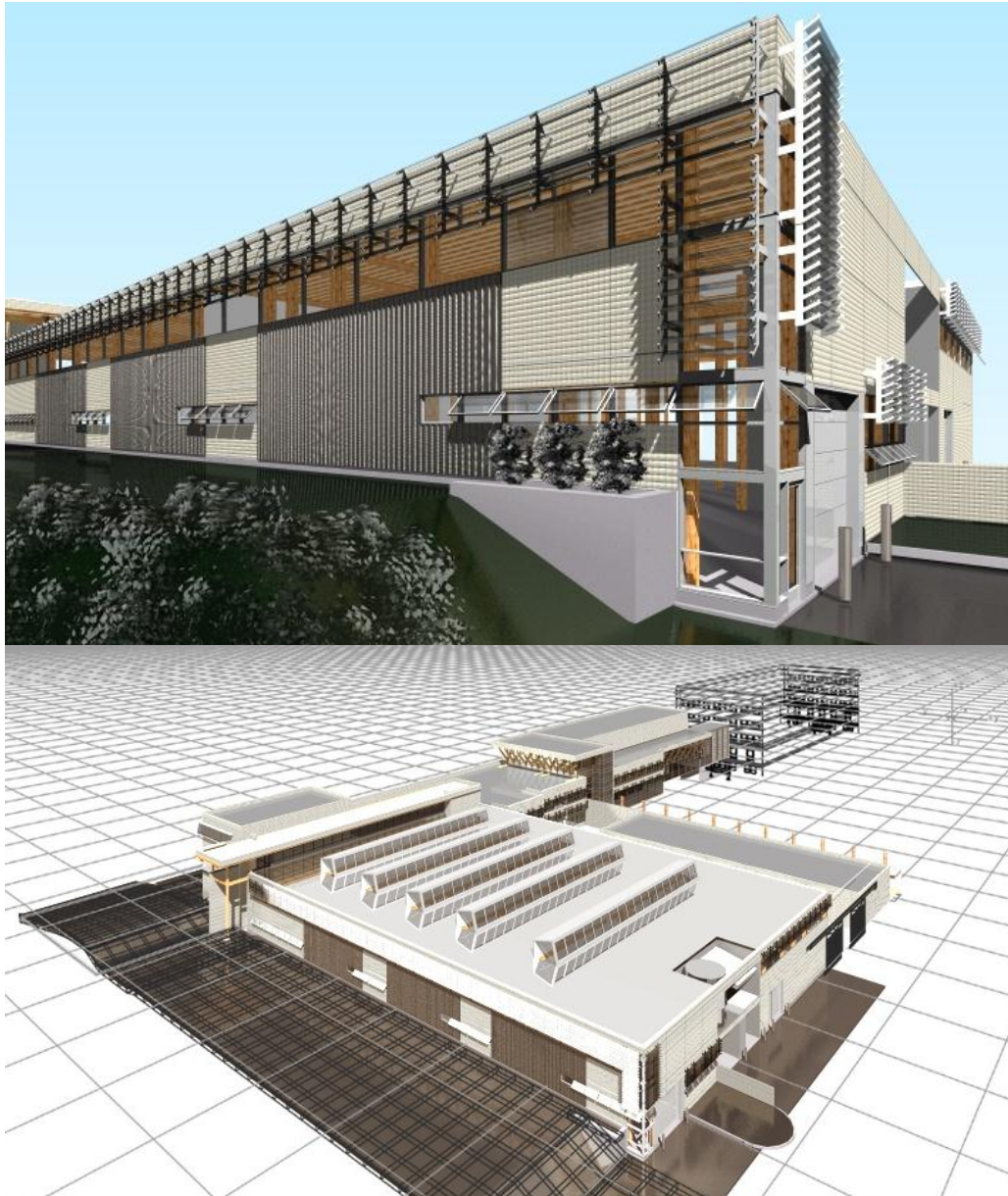

Figure 18: Presentation drawings showing bioclimatic concepts with Form•Z (Source: Laurent Goulard)

3.2.5. Economic analysis

According to Potvin and Demers (2007), the building led to an estimated 32% potential savings in operating energy consumption when compared with a reference building as defined by the Canadian MNECB (Model National Energy Code for Buildings). Figure 19 shows the final energy performance and the annual cost of the reference building (27.96 CAD\$/m²) compared with the proposed building (25.16 CAD\$/m²).

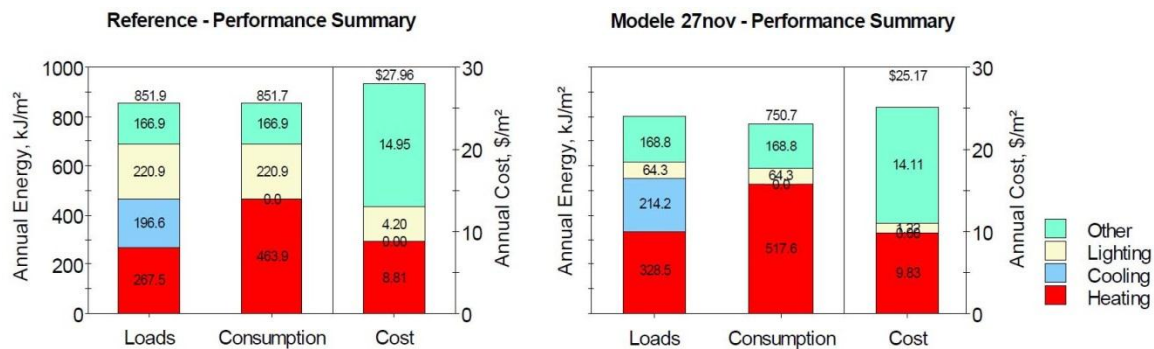

Figure 19: Left: Simulation showing the overall energy consumption of a reference building, Right: Simulation showing the overall energy consumption of the proposed building (Source: Potvin and Demers, 2007)

3.2.6. Barriers in using tools for solar design and lessons learned

About simulation tools, the Energy-10 tool appeared as fast and easy to use for the preliminary phase because of the many values set by default. Also, the main particularity of the final simulation made with EE4 in the final phase was the building's mechanical system, which is powered by the power plant on the campus of Laval University. An average efficiency of 80% should be imposed, while the actual performance is beyond this percentage.

Apart from the tool, the building shows that solar elements, like sun shading devices, are a part of the building that need to be evaluate as a whole in order to avoid problems and to be really well integrated. In the building, it happened that there was a thermal bridge because of the sun shading device (Figure 20). To eliminate this, the metal components were covered by an insulating material. Indeed, the consultant Claude Demers says that the best "tool" used in the design process were the weekly meetings with the design team to be able to explain, set specific topics, answer questions and most importantly, provide knowledge to architectural theory and translate the information to the architects. She also says that she gave many rules of thumb, acquired through experience and background, which helped architects to work with solar concepts. Claude Demers admits that she gave "a good course about daylighting" since the calculation must be translated into architecture, and this is where it becomes a force. She adds that complex tools may waste time when they are used in the initial stages of design. Therefore, the building Eugene H. Kruger demonstrates very clearly that the simple tools for the initial phases of design were essential to effectively integrate solar architecture, optimize skylight and sun shading devices, qualify and quantify the architectural concepts or obtain LEED® points (even if the building is not certified). Simulations tools have proven to be good decision-supporting tools, which however must be used with appropriate knowledge. According to Boivin (2007), beyond the tool, the fundamental matter is the professionals' knowledge, emphasizing the importance of transdisciplinarity to understand concepts of other professions, both systemic and perceptual ways to work. This is what emerges from the design team of the project, which favoured a both pragmatic and artistic approach providing a high quality life on the campus, humanized with a natural light with health benefits.



Figure 20: Thermal bridge before putting insulating material on the metal component of the sun shading device

3.3. Plus Energy Primary School, Hohen Neuendorf (near Berlin, Germany)

The Plus Energy Primary School was finished in 2011. It is located in a growing town in the north of Berlin. Because of the increasing number of inhabitants a new primary school with gymnasium was needed. The city of Hohen Neuendorf currently had sufficient funding for the project, so when they defined the call for the architectural competition for the new school building, they already thought about the future: so one aspect which had to be taken into account was low operational costs.

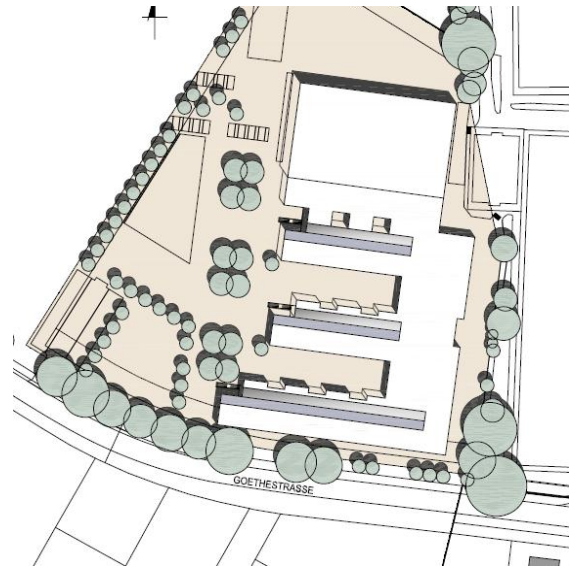

3.3.1. Methods (process)

After winning the competition for building a new primary school in Hohen Neuendorf (near Berlin), IBUS Architekten und Ingenieure and a newly built working group around IBUS were commissioned to build the school. As mentioned the awarding authority was asking for a new school building with special focus on low operation costs, but the working group even wanted to achieve more than that. They were able to convince the city of Hohen Neuendorf to not only build a low energy building but a plus energy school. In order to realize the ambitious concept and to get feedback if the building is really working as planned, funding from the German government was acquired. With this funding the following parts were financed:

- Accompanying research
- Innovative building materials: vacuum insulation panels, light redirecting glazing, electro chromic glazing, vacuum glazing, nanogel glazing
- System engineering: LEDs, filters, motors for operable windows, display for visualizing need of ventilation in classrooms, CHP plant with Stirling motor for wooden pellets or CHP for vegetable oil
- Monitoring (2 year monitoring phase including FDD (Fault Detection and Diagnosis))



Figure 21: Street view (left) and outside view (right) of the Plus Energy Primary School.

3.3.2. Tools used

Computer simulations were carried out during different project phases. First minor simulations were performed during the preliminary design phase. More extensive simulations were carried out later, in the more detailed phases. Ecotect and Radiance simulations were done during August and September 2009 (construction drawing phase). Relux and TRNSYS simulations were performed during January and February 2010 (construction drawing phase). The tools used were:

- AutoCAD
- Autodesk REVIT Architecture
- Autodesk Ecotect
- Radiance
- Relux
- PV*Sol
- TRNSYS
- Modelica for monitoring (no influence on design).

3.3.3. Aesthetical aspects through tools

The architectural concept was planned to create “home zones” for the students. This means that every school class, instead having just one classroom, would have a “home zone” which consists of the classroom, an extra small classroom, the corridor in front of the classrooms, an own sanitary room and a wardrobe. The “home zones” were investigated more in detail, in order to assure that the daylight availability was optimized while no overheating took place during summertime. The shading system was dimensioned with the help of the daylight simulation program. The simulations showed that the architectural concept was working and did not have to be changed.

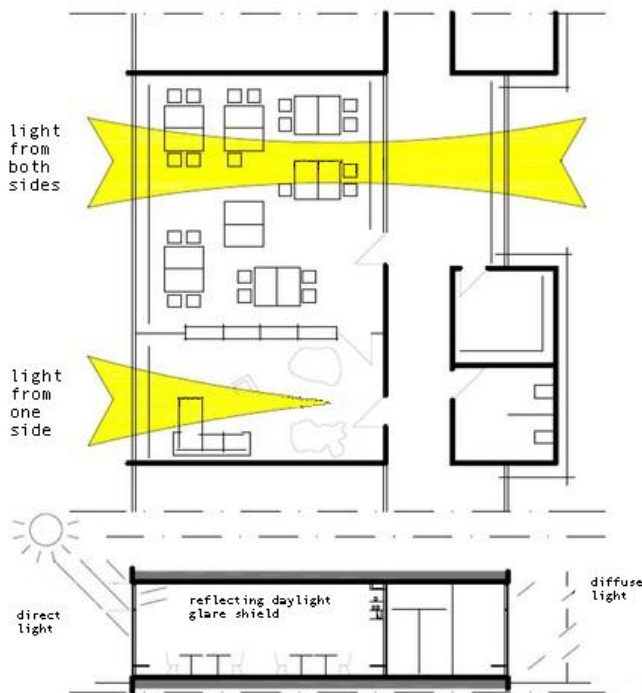

Figure 22: Daylight concept for the home zones.

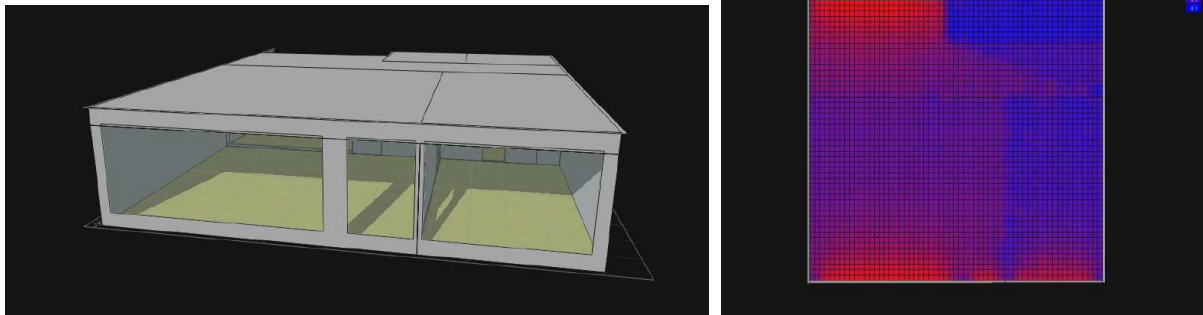

Figure 23: Classroom model (left) and daylight analysis (right) with Ecotect

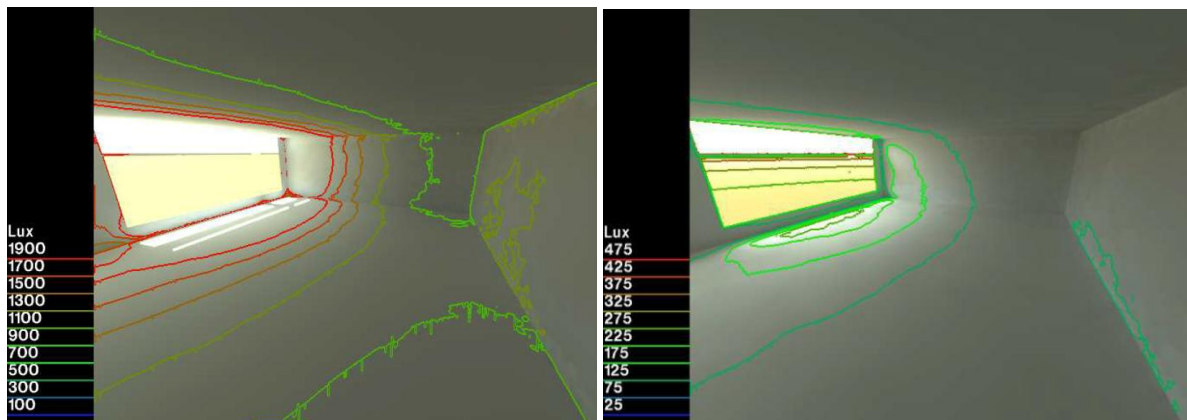

Figure 24: Optimized classroom model, 1st of August, 12:00 (left), 24th of December, 12:00 (right); Radiance.

Daylight simulations were realized also for other areas of the school. In case of the gymnasium they showed that, in order to get homogeneous illumination levels, some roof lights had to be added. In the auditorium no changes in design were necessary.



Figure 25: Gymnasium of the school with light dispersing glazing (left); Auditorium/cafeteria with electro chromic glazing (right).

Simulation of artificial light influenced the positioning of the luminaires. Goal was reaching uniform illumination levels in most areas.

The roof is mainly flat, but in order to create a space for the ventilation system, there are some parts with span-roof. It was called technical roof during the project. The south slope of these technical roofs was optimized for PV application.

3.3.4. Technical aspects through tools

Thermal simulation was used to define the size of operable window area for natural ventilation in the home zones.

The PV system's yield was calculated using PV*Sol. The dimensioning of the system, the selection of PV modules and inverters were done using the computer tool.



Figure 26: Roof with PV system and roof light (left); Screenshot of the PV system planned with PV*Sol (right).

3.3.5. Economic analysis

The Plus Energy Primary School had nearly the same costs in comparison to conventionally new built school buildings. The energy costs will be a lot lower than the costs of normal new school buildings. After the PV system is charged off, the annual energy costs will be even lesser.

3.3.6. Analysis through tools

There were different persons running the simulations or working with the tools. In the architectural office REVIT was used to build a model of a classroom which was later imported in Ecotect for optimizing the daylight situation in the home zones. Further, a more detailed analysis was carried out with Radiance. As normal drawing tool for the 2D building model, AutoCAD was used. The engineering office also used AutoCAD. Daylight and artificial light simulations for the gymnasium and the auditorium were done with Relux. Thermal and ventilation comfort in the home zones was tested with TRNSYS and the PV system was dimensioned with the help of PV*Sol. In the University of

Applied Sciences, Berlin, a model of the whole building was made using Modelica as part of a Master's thesis. This building model helps to evaluate the influence of different parameters and will be used during the monitoring phase for FDD.

3.3.7. Barriers in using tools for solar design and lessons learned

The main barriers for applying more simulations during the planning process are the costs and the time for running them. Depending on the input data, the results are more or less valuable. The influence of the users or the reliability of data is very big.

It is also time consuming that there are a lot of different computer tools that are not interoperable, so the building geometry or parts of it have to be entered in every tool separately. The used simulation tools were also more suited for the detailed design phase. Only the daylight analyses of the "home zones" were done in the architectural office. All other analyses and simulations were performed by the energy consultant. Thus, the feedback on the consequences of architectural decisions was not immediately available for the architects. This also slows down the optimization process.

3.3.8. Involved offices and authorities

<i>Awarding authority</i>	City Hohen Neuendorf
<i>Project coordination, Architecture, Construction management, Daylight concept, Building physics</i>	IBUS Architekten und Ingenieure, Berlin, Bremen Prof. Ingo Lütkemeyer Dr. Gustav Hillmann Hans-Martin Schmid
<i>Building services, Energy concept, Thermal simulations, Daylight simulations</i>	BLS Energieplan GmbH, Berlin Jens Krause Marko Brandes
<i>Accompanying research, coordination</i>	sol-id-ar planungswerkstatt, Berlin Dr. Günter Löhnert
<i>Ecobalance, Life cycle analysis</i>	Ascona GbR Holger König
<i>Acoustics</i>	Dr. Detlef Hennings
<i>Monitoring</i>	HTW (University of Applied Sciences)/ IB Sick, Berlin Prof. Dr. Friedrich Sick
<i>Project funding</i>	Bundesministerium für Wirtschaft und Technologie – EnOB-Programme, Eneff-Schule

4. FINAL REMARKS

As the concerns increase about world's dependency on limited reserves of fossil fuels, evident changes in climate and increased greenhouse gas emissions, it has become necessary to seek solutions and employ resources that still have been untapped. In addition, in many countries and regions requirements for new buildings to be Net Zero Energy (or even Plus Energy buildings) are becoming mandatory. This means that new buildings will not only have to conserve energy but also to produce it. Solar energy can provide a significant portion of energy needs in buildings in most regions of the world.

Architects, as professionals who hold a key role at the early design phase of buildings, can tremendously influence the overall building energy performance through decisions made at this phase by including active and passive solar strategies from the early conceptual design. Recognising the importance of this, the International Energy Agency, Solar Heating and Cooling Programme (IEA SHC), commenced the Task 41: Solar Energy and Architecture. The goals were to identify obstacles that architects are facing with solar building design at the early design phase, to provide resources for overcoming these barriers and to help improving architects' communication with other stakeholders in the design of solar buildings.

The research done at earlier stages of *Subtask B: Tools and methods for solar design*, of the Task 41, identified issues related to currently available digital tools that architects can use for solar design. This research showed that a vast number of digital tools exist today: tools that perform different tasks, require different level of input data and produce different results. Some provide more qualitative outputs, and others can produce detailed calculations and quite precise qualitative (numerical) solutions. Some are simple and, in many cases, free to use, while others can be a part of larger and, often, costly software package, intended for highly skilled professionals.

This publication intended to raise awareness and provide guidance for architects about performance and capabilities of existing tools for solar design. The report presents 2 graphic / physical tools (i.e. solar charts and artificial sky setup) and 17 digital tools that have capability to help with solar design: from simple and qualitative to detailed and quantitative assessment of proposed design solutions. The choice of tools presented here was based on the report: *International survey about digital tools used by architects for solar design. Report T.41.B.2.* (Horvat & Dubois (eds.), 2011). The intention was not to compare and judge tools against each other, but, rather to provide an initial resource for architects who are interested to learn more and/ or need to make a choice about tool for solar design.

In addition, this report presents three exemplary case stories, which, hopefully, provide a valuable knowledge as they describe different design approaches, which tools and how they were used in the solar design process. In one, a client's decision to include solar and energy efficient design at the later stage of the architectural design prompted adjustments in the architects' original proposal; in another, the architectural design team worked closely from the beginning with researchers and consultants and verified each design decision through digital and physical simulations, while in the third case it was an engineering team (energy consultants) that drove the design not only to meet client's requirement (Net Zero Energy building), but to exceed them and create a Plus Energy building.

Finally, the process of gathering information about each tool, simulating the same building complex massing model developed for this purpose and understanding the simulation results in each particular case provided additional valuable input to participating Task 41 experts. It helped them in developing and refining the list of needs of architects regarding tools for solar building design, that were originally identified through the already mentioned international survey of architects in all 14 participating countries. The needs of architects will be communicated to tool developers in order to

initiate discussion and thought sharing about adaptation and improvements of tools to better suit the needs of architects in solar design at the early design stage.

REFERENCES

- Autodesk (2010), Tutorial of Autodesk Ecotect Analysis 2010. Autodesk, Inc. USA.
- Bernardo R. (2011). *Retrofitted Solar Thermal System for Domestic Hot Water for Single Family Electrically Heated Houses*. Licentiate Thesis. Report EBD-T—10/13. Division of Energy and Building Design, Department of Architecture and Built Environment, Lund University, Sweden, available at: http://www.ebd.lth.se/fileadmin/energi_byggnadsdesign/images/Publikationer/Bok_lic_avhandl_RB_webb.pdf
- Bodart M., Deneyer A., De Herde A., Wouters P., (2006), Design of a new single patch sky and sun simulator, *Lighting Research and Technology*, Vol. 38 (1), p. 73-89, 2006.
- Bodart M., Deneyer A., Gilbert V., (2008), Validation of the Belgian single patch sky and sun simulator, *Building and Environment*, 43(11), p. 1892-1901, 2008.
- Boivin, H. (2007). *La Ventilation naturelle: Développement d'un outil d'évaluation du potentiel de la climatisation passive et d'aide à la conception architecturale*. Université Laval Québec.
- BS 8206-2 1992, Lighting for buildings-part 2: Code of practice for daylighting.
- Demers, C., Potvin, A. (2004), LUMcalcul 2.01: prédiction de la lumière naturelle pour la conception architecturale, *Proceedings of eSIM2004*, Vancouver 9 -11 June 2004.
- Devin B. (2006). Développement, énergie, environnement : changer de paradigme. *Les cahiers de Global Chance*. No 21 (2006). p. 44.
- Dubois M-C & Horvat M (Eds.) (2010). *State-of-the-art of digital tools used by architects for solar design. Report T.41.B.1*. IEA SHC Task 41 Solar Energy and Architecture. 121 pages. Available at: http://www.iea-shc.org/publications/downloads/IEA-T41_STB-DB1_SOA-DigitalTools.pdf
- Dubois, M-C, J. Kanters and M.Horvat, (2011), Tools and methods used by architects for solar design: results of an international survey in 14 countries, *CISBAT 2011 - Clean tech for sustainable buildings: from nano to urban scale*, Lausanne, Switzerland, September 14-16, 2011, Book of abstracts p. 178 and paper published on CD-rom.
- EPBD Recast, (2012), Directive 2010/31 /EU of the European parliament and of the council of 19 may 2010 on the energy performance of buildings (recast) available at http://www.eceee.org/buildings/EPBD_Recast
- European Parliament (2009). Legislative Resolution of 23 of April 2009 on the proposal for a Directive of the European Parliament and of the Council on the energy performance of buildings, last accessed 2011-01-17 from <http://www.europarl.europa.eu/sides/getDoc.do?type=TA&reference=P6-TA-2009-0278&language=EN>
- European Renewable Energy Council (2010). *RE-thinking 2050-a 100% renewable energy vision for the European Union*. Accessed 2011-01-17 from <http://www.erec.org/>
- Federal Institute for Geosciences and Natural Resources (2009). *Reserves, resources and availability of energy resources – BGR 2009*. Accessed 2011-01-17, <http://www.tsl.uu.se/uhdsg/Data/BGR/BGR2009.pdf>
- Gagnon, S., Dubois, M.-C. & Horvat, M. (2010), High quality solar architecture: do architects have tools supporting early design phase decisions?, In *Proceedings of Eurosun 2010*, Graz, Austria, 28th Sep. – 1st Oct, 2010, published on CD-rom, ISBN 978-3-901425-13-4.
- GRAP (2011). Simulation-evaluation. Accessed on 13-Nov-2011. <http://www.grap.arc.ulaval.ca/Ensemble.htm>

- Hagen, R., Jørgensen, O. (Eds.) (2012), *The Communication Process, Report T.41.C.3. Communication guideline*, available at <http://www.iea-shc.org/publications/downloads>
- Horvat, M., Dubois, M.-C., Snow, M., & Wall, M. (2011). *International survey about digital tools used by architects for solar design. Report T.41.B.2.* IEA SHC Programme Task 41: Solar Energy and Architecture: [http://www.iea-shc.org/publications/downloads/International Survey About Digital Tools Used by Architects for Solar Design.pdf](http://www.iea-shc.org/publications/downloads/International_Survey_About_Digital_Tools_Used_by_Architects_for_Solar_Design.pdf)
- IEA (2009). SHC Task 41: Solar Energy and Architecture. Annex Plan December 2008. online at www.iea-shc.org/publications/downloads/task41-Annex.pdf
- IPCC – Intergovernmental Panel for Climate Change (2007). *Assessment Report 4.* Accessed 2011-01-17 from http://www.ipcc.ch/pdf/assessment-report/ar4/syr/ar4_syr.pdf
- Kanters, J. (2011). Adequacy of current design tools and methods for solar architecture – results of IEA-SHC Task 41's international survey, In *Proceedings of PLEA 2011 - 27th Conference on Passive and Low Energy Buildings*, Louvain-la-neuve, Belgium, 13-15 July, 2011, Vol.2, 65-70.
- Kanters, J., Dubois, M.-C. & Wall, M., (2012), Architects' Design Process in Solar Integrated Architecture in Sweden, accepted and pending publication at *Architectural Science Review*.
- Kanters, J., Horvat, M. & Dubois, M.-C. (2012), Tools and methods used by architects for solar design, submitted and pending review at *Energy and Buildings*.
- Korolkow, M., Horvat, M., Dubois, M.-C., Kanters, J. & Bouffard. É., (2011), Tools and methods for solar building design: results of IEA Task 41 international survey, in *ISES Solar World Congress 2011 Proceedings*, (DVD, ISBN 978-3-9814659-0-7), Kassel, Germany, 28th Aug.- 2nd Sept, 2011.
- Larsson N (2004). Le Processus de conception intégrée. Ottawa. http://www.envirobat-med.net/IMG/pdf/PCI_20sommaire_20PDF.pdf
- Livingston H (2007). BIM and Sustainable Design, Part 2. Design software companies use different approaches to reach the same goal. <http://www.cadalyst.com/cad/building-design/bim-and-sustainable-design-part-2-3618>
- Marsh, A., (2007), Why Do Shading Calculations Take so Long?, *Natural Frequency*, ISSN: 1833-7570, Issue No. 004, November 01, 2007, retrieved March 19, 2012 from <http://naturalfrequency.com/articles/shadingcalculations>
- Perez, R., Seals, R., Michalsky, J., (1993). All-Weather Model for Sky Luminance Distribution – Preliminary Configuration and Validation, *Solar Energy*, 50(3), 235-245.
- Pfitzner M, Bögl M, Neuberger F, Tulke J, Hochtief, Nummelin O, Benning P, Bouygues (2007). *Analysis of existing software tools for early design. Inpro report.* July 2007. European Commission, sixth framework programme.
- Potvin, A., Demers, C., Boivin, H. (2004), PETv4.2 Les profils d'équilibre thermique comme outil d'aide à la conception architecturale, *Proceedings of eSIM2004*, Vancouver 9 -11 juin 2004
- Potvin, A., Demers, C., (2007), Passive environmental control strategies for a cold climate: the Eugene-H-Kruger Building at Laval University, in the *Conference Proceedings of the American Solar Energy Society (ASES), SOLAR 2007*, 7-12 July, Cleveland, Ohio.
- PVsyst: Studies, sizing and simulation <http://www.pvsyst.com/>
- Reinhart, C. F., Walkenhorst, O., (2001). Dynamic RADIANCE-based daylight simulations for a full-scale test office with outer venetian blinds. *Energy & Buildings*, 33:7 pp. 683-697.

Reinhart, C. F., *Daylight Availability and Manual Lighting Control in Office Buildings – Simulation Studies and Analysis of Measurements*. Ph.D. thesis, Technical University of Karlsruhe, Faculty of Architecture, October 2001.

Reinhart, CF. (2006), *Tutorial on the Use of Daysim Simulations for Sustainable Design*. Institute for Research in Construction National Research Council Canada.

Reinhart, CF. (2010), *Tutorial on the Use of Daysim Simulations for Sustainable Design*. Graduate School of Design, Harvard University.

SBRN: Solar Building Research Network, Background (2010) last accessed May 2012 from <http://www.solarbuildings.ca>

Solomon T. & Bedel S. (2003). *La Maison des (néga) watts: Le Guide malin de l'énergie chez soi*. Terre vivante publishers, France.

WBCSD (2009). Energy efficiency in buildings: Transforming the market. World Business Council for Sustainable Development, online at www.wbcsd.org

Zero Net Energy, Action Plan: Commercial Building Sector 2010-2012. CA Energy Efficiency Strategic Plan (2010). Last accessed 2011-01-17 from <http://www.cpuc.ca.gov/NR/ronlyres/6C2310FE-AFE0-48E4-AF03-530A99D28FCE/0/ZNEActionPlanFINAL83110.pdf> and http://docs.cpuc.ca.gov/PUBLISHED/NEWS_RELEASE/122911.htm



IEA SOLAR HEATING AND COOLING PROGRAMME

The International Energy Agency (IEA) is an autonomous body within the framework of the Organization for Economic Co-operation and Development (OECD) based in Paris. Established in 1974 after the first “oil shock,” the IEA is committed to carrying out a comprehensive program of energy cooperation among its members and the Commission of the European Communities.

The IEA provides a legal framework, through IEA Implementing Agreements such as the Solar Heating and Cooling Agreement, for international collaboration in energy technology research and development (R&D) and deployment. This IEA experience has proved that such collaboration contributes significantly to faster technological progress, while reducing costs; to eliminating technological risks and duplication of efforts; and to creating numerous other benefits, such as swifter expansion of the knowledge base and easier harmonization of standards.

The Solar Heating and Cooling Programme was one of the first IEA Implementing Agreements to be established. Since 1977, its members have been collaborating to advance active solar and passive solar and their application in buildings and other areas, such as agriculture and industry. Current members are:

Australia	Germany	Portugal
Austria	Finland	Singapore
Belgium	France	South Africa
Canada	Italy	Spain
China	Mexico	Sweden
Denmark	Netherlands	Switzerland
European Commission	Norway	United States

A total of 49 Tasks have been initiated, 35 of which have been completed. Each Task is managed by an Operating Agent from one of the participating countries. Overall control of the program rests with an Executive Committee comprised of one representative from each contracting party to the Implementing Agreement. In addition to the Task work, a number of special activities—Memorandum of Understanding with solar thermal trade organizations, statistics collection and analysis, conferences and workshops—have been undertaken.

Visit the Solar Heating and Cooling Programme website - www.iea-shc.org - to find more publications and to learn about the SHC Programme.

Current Tasks & Working Group:

- Task 36 Solar Resource Knowledge Management
- Task 39 Polymeric Materials for Solar Thermal Applications
- Task 40 Towards Net Zero Energy Solar Buildings
- Task 41 Solar Energy and Architecture
- Task 42 Compact Thermal Energy Storage
- Task 43 Solar Rating and Certification Procedures
- Task 44 Solar and Heat Pump Systems
- Task 45 Large Systems: Solar Heating/Cooling Systems, Seasonal Storages, Heat Pumps
- Task 46 Solar Resource Assessment and Forecasting
- Task 47 Renovation of Non-Residential Buildings Towards Sustainable Standards
- Task 48 Quality Assurance and Support Measures for Solar Cooling
- Task 49 Solar Process Heat for Production and Advanced Applications

Completed Tasks:

- Task 1 Investigation of the Performance of Solar Heating and Cooling Systems
- Task 2 Coordination of Solar Heating and Cooling R&D
- Task 3 Performance Testing of Solar Collectors
- Task 4 Development of an Insolation Handbook and Instrument Package
- Task 5 Use of Existing Meteorological Information for Solar Energy Application
- Task 6 Performance of Solar Systems Using Evacuated Collectors
- Task 7 Central Solar Heating Plants with Seasonal Storage
- Task 8 Passive and Hybrid Solar Low Energy Buildings
- Task 9 Solar Radiation and Pyranometry Studies
- Task 10 Solar Materials R&D
- Task 11 Passive and Hybrid Solar Commercial Buildings
- Task 12 Building Energy Analysis and Design Tools for Solar Applications
- Task 13 Advanced Solar Low Energy Buildings
- Task 14 Advanced Active Solar Energy Systems
- Task 16 Photovoltaics in Buildings
- Task 17 Measuring and Modeling Spectral Radiation
- Task 18 Advanced Glazing and Associated Materials for Solar and Building Applications
- Task 19 Solar Air Systems
- Task 20 Solar Energy in Building Renovation
- Task 21 Daylight in Buildings
- Task 22 Building Energy Analysis Tools
- Task 23 Optimization of Solar Energy Use in Large Buildings
- Task 24 Solar Procurement
- Task 25 Solar Assisted Air Conditioning of Buildings
- Task 26 Solar Combisystems
- Task 27 Performance of Solar Facade Components
- Task 28 Solar Sustainable Housing
- Task 29 Solar Crop Drying
- Task 31 Daylighting Buildings in the 21st Century
- Task 32 Advanced Storage Concepts for Solar and Low Energy Buildings
- Task 33 Solar Heat for Industrial Processes
- Task 34 Testing and Validation of Building Energy Simulation Tools
- Task 35 PV/Thermal Solar Systems
- Task 37 Advanced Housing Renovation with Solar & Conservation
- Task 38 Solar Thermal Cooling and Air Conditioning

Completed Working Groups:

CSHPSS; ISOLDE; Materials in Solar Thermal Collectors; Evaluation of Task 13 Houses; Daylight Research